

# Operating Manual

## Mixing pump G 4 X FU 230/400V Part 2 EC Declaration of Conformity Overview - Operation



Article number of the operating manual: 00 43 75 45

Article number of the machine: 00 26 06 21

Article number of the machine: 00 42 34 08

Article number of the machine: 00 42 21 35

Article number of the machine: 00 42 39 50

**CE**

**Read the operating manual prior to starting any work!**

© Knauf PFT GmbH & Co. KG  
P.O. Box no. 60 97343 Iphofen  
Einersheimer Straße 53 97346 Iphofen  
Germany

Phone: +49 (0) 93 23/31-760  
Fax: +49 (0) 0 93 23/31-770  
Technical hotline +49 9323 31-1818

info@pft-iphofen.de  
Internet: www.pft.eu



## Table of Contents

<b>1 EC Declaration of Conformity</b> .....	<b>6</b>	11.2 Selector switch pump motor.....	15
<b>2 Examination</b> .....	<b>7</b>	11.3 Selector switch pressure booster pump .....	16
2.1 Examination by machine operator .....	7	11.4 Voltage 230/400V changing .....	16
2.2 Periodic inspection.....	7	<b>12 Accessories</b> .....	<b>16</b>
<b>3 General information</b> .....	<b>8</b>	12.1 Adapter cable .....	17
3.1 Information regarding the operating manual .....	8	<b>13 Intended use Control panel</b> .....	<b>18</b>
3.2 Keep the manual for future reference .....	8	13.1 Intended purpose control panel.....	18
3.3 Division .....	8	13.2 Intended purpose solenoid valve .....	18
3.4 Spare parts lists .....	8	13.3 Intended purpose flow meter.....	18
<b>4 Technical data</b> .....	<b>9</b>	<b>14 Intended use air compressor</b> .....	<b>19</b>
4.1 General information .....	9	14.1 Intended purpose air compressor .....	19
4.2 Power connection .....	9	14.2 Safety systems air compressor .....	20
4.3 Operating conditions .....	9	14.3 Pressure switch-off air compressor.....	20
4.4 Power values .....	10	14.4 Dry-running air compressor.....	20
4.5 Sound power level .....	10	<b>15 Description PFT Booster pump (Accessory)</b> .....	<b>21</b>
4.6 Vibrations .....	10	15.1 Scope of application Booster pump .....	21
<b>5 Dimension sheet</b> .....	<b>11</b>	15.2 Intended use.....	21
<b>6 Name plate</b> .....	<b>11</b>	<b>16 Preparation booster pump AV3 (accessory)</b> .....	<b>22</b>
<b>7 Quality Control sticker</b> .....	<b>11</b>	<b>17 Initial start-up booster pump</b> .....	<b>22</b>
<b>8 Assembly</b> .....	<b>12</b>	17.1 Start-up Booster pump .....	22
8.1 Overview .....	12	<b>18 Description G 4 X FU 230/400V</b> .....	<b>23</b>
<b>9 Description of assemblies</b> .....	<b>13</b>	18.1 Functional principle G 4 X FU 230/400V .....	23
9.1 Hopper .....	13	18.2 Functional description G 4 X FU 230/400V .....	24
9.2 Control cabinet article number 00 25 46 51 .....	13	18.3 Fields of application.....	24
9.3 Mixing tube with motor and pump.....	14	<b>19 Material:</b> .....	<b>24</b>
9.4 Water fitting.....	14	19.1 Flowability / Flow characteristics .....	24
9.5 Air compressor DELTA2 230V with pressure switch-off .....	14	<b>20 Mortar pressure gauge</b> .....	<b>25</b>
<b>10 Connections</b> .....	<b>15</b>	<b>21 Safety rules</b> .....	<b>25</b>
<b>11 Operating modes</b> .....	<b>15</b>		
11.1 Selector switch star wheel .....	15		

**Table of Contents**



<b>22 Transport, packing and storage ....</b>	<b>25</b>		
22.1 Safety instructions for transport .....	25		
22.2 Transport inspection.....	26		
22.3 Transport.....	27		
22.4 Transport with van.....	27		
22.5 Transport in individual parts.....	28		
<b>23 Packaging .....</b>	<b>28</b>		
<b>24 Operation .....</b>	<b>29</b>		
24.1 Safety .....	29		
<b>25 Safety system.....</b>	<b>29</b>		
<b>26 Preparing the machine .....</b>	<b>30</b>		
<b>27 Connecting the power supply</b>			
<b>400V .....</b>	<b>30</b>		
27.1 Check the individual connectors .....	31		
27.2 Connecting the water supply.....	31		
27.3 Connection of water from water tank ...	32		
<b>28 Switching on the G 4 X (400V) .....</b>	<b>33</b>		
28.1 Putting the machine into operation			
(400V) .....	33		
28.2 Set water quantity .....	33		
28.3 Soaking of the mixing section .....	34		
<b>29 Mortar pressure gauge .....</b>	<b>34</b>		
<b>30 Hazardous dusts .....</b>	<b>34</b>		
30.1 Anti-dust unit for G 4 completely.....	35		
<b>31 Feeding dry material to the</b>			
<b>machine .....</b>	<b>35</b>		
<b>32 Monitoring the machine.....</b>	<b>36</b>		
<b>33 Putting the machine into</b>			
<b>operation .....</b>	<b>37</b>		
33.1 Check consistency of mortar.....	37		
33.2 Start the machine in a “flying” mode			
(400V) .....	37		
<b>34 Mortar hoses .....</b>	<b>38</b>		
34.1 Prepare mortar hoses .....	38		
		34.2 Connect mortar hose .....	38
<b>35 Compressed air supply .....</b>	<b>39</b>		
35.1 Connect air hose.....	39		
35.2 Connecting the spraying gun .....	39		
35.3 Switch on air compressor .....	39		
<b>36 Apply mortar.....</b>	<b>40</b>		
36.1 Open the air tap at the spraying gun ...	40		
36.2 Interruption of work .....	41		
36.3 In case of longer interruption of			
work/break .....	41		
36.4 Switch off air compressor .....	41		
<b>37 Remote control.....</b>	<b>42</b>		
37.1 Working with the remote control .....	42		
<b>38 Stopping in case of emergency</b>			
<b>Emergency-stop switch.....</b>	<b>42</b>		
38.1 Emergency-stop switch.....	42		
<b>39 Measures in case of power cut .....</b>	<b>43</b>		
39.1 Main switch to position “0“ .....	43		
39.2 Relieve mortar pressure .....	43		
<b>40 Work on troubleshooting.....</b>	<b>44</b>		
40.1 Reaction in the event of faults .....	44		
40.2 Fault displays.....	45		
40.3 Faults .....	45		
40.4 Safety.....	45		
40.5 Table of faults .....	46		
40.6 Signs for hose blockages: .....	48		
40.7 Causes for this can be:.....	49		
40.8 Earlier damage to the mortar hose.....	49		
<b>41 Removal of blockages in the hose 49</b>			
41.1 Change the direction of rotation of the			
mixing pump motor in case of			
blockages in the hose (400V) .....	49		
41.2 Change the direction of rotation of the			
mixing pump motor in case of			
blockages in the hose (230V).....	50		
41.3 Blockage does not dislodge.....	50		
41.4 Switch the machine back on after the			
blockage has been removed (400V) .	51		



**Table of Contents**

41.5 Switch the machine back on after the blockage has been removed (230V) . 51

**42 Connection of power supply (230V) ..... 52**

42.1 Voltage 230V ..... 52

**43 Connecting the power supply 230V ..... 52**

**44 Switching on (230V)..... 53**

44.1 Putting the machine into operation (230V) ..... 53

**45 Start the machine in a “flying” mode 230V ..... 53**

**46 Cleaning the machine after work .. 54**

46.1 Empty the mixing tube ..... 54

46.2 Secure against restarting ..... 54

46.3 Cleaning the G 4 X ..... 55

46.4 Decouple mortar hose ..... 55

46.5 Clean mortar hose ..... 55

46.6 Remove the water hose ..... 56

46.7 Cleaning the mixing tube ..... 56

46.8 Insert the mixing tube cleaner ..... 56

46.9 Close motor tilt flange ..... 57

46.10 Insert agitator ..... 57

46.11 Cleaning the hopper ..... 58

**47 Changing the pump / Cleaning the pump ..... 58**

47.1 Fold up mixing tube ..... 58

47.2 Clean rubber mixing section ..... 58

**48 Switch off G 4 X ..... 59**

**49 Measures in case of risk of frost... 59**

49.1 Blow dry water fitting ..... 60

49.2 Switch on air compressor ..... 60

**50 Maintenance ..... 61**

50.1 Safety ..... 61

50.2 Remove connection cable ..... 62

50.3 Environmental protection ..... 62

50.4 Maintenance plan ..... 63

50.5 Maintenance work ..... 63

50.6 Adjust locking lever ..... 65

50.7 Measures after effected maintenance.. 65

**51 Disassembly..... 66**

51.1 Safety ..... 66

51.2 Disassembly ..... 67

**52 Disposal..... 67**

**53 Index ..... 68**

## EC Declaration of Conformity



### 1 EC Declaration of Conformity

**Company:** Knauf PFT GmbH & Co. KG  
Einersheimer Straße 53  
97346 Iphofen  
Germany

declares under our sole responsibility that the product:

**Type of machine:** G 4 X  
**Type of equipment:** Mixing pump  
**Serial number:**  
**Guaranteed sound power level:** 95 dB

is in conformity with the following CE directives:

- Outdoor directive (2000/14/EC),
- Machine directive (2006/42/EC),
- Electromagnetic Compatibility Directive (2014/30/EU).

Operative Conformity Assessment according to Outdoor Directive 2000/14/EC:

Internal production control as per article 14 paragraph 2 in connection with annex V.

This declaration only refers to the machine in the state in which it has been placed on the market. Parts subsequently added by the user and/or subsequent interventions are not covered. This declaration ceases to be valid if the product is converted or changed without consent.

**Person authorised to compile the relevant technical documentation:**

Diploma in industrial engineering (FH) Michael Duelli, Einersheimer Straße 53, 97346 Iphofen.

**The technical documentation is available from:**

Knauf PFT GmbH & Co.KG, Technical Department, Einersheimer Straße 53, 97346 Iphofen.

Iphofen

Place, date of issue

Name and signature

Dr. York Falkenberg

Managing director  
Details of signatory

## 2 Examination

### 2.1 Examination by machine operator

- Prior to each shift, the machine operator has to examine the effectiveness of the control and safety devices as well as the proper fitting of the protection devices.
- The safe working condition of construction machinery has to be checked by the machine operator during operation.
- If the safety devices show any defects or if any other defects are detected that compromise a safe operation, the supervisor has to be informed immediately.
- In case of defects that cause harm to persons, the operation of the construction machine has to be stopped to eliminate the defects.

### 2.2 Periodic inspection

- Construction machinery has to be inspected for their safe working condition in accordance with the operating conditions and the operational requirements as needed, however at least once a year by an expert.
- Pressure vessels have to undergo the prescribed expert inspections.
- The inspection results have to be documented and kept at least until the next inspection.



## 3 General information

### 3.1 Information regarding the operating manual

This operating manual gives important information on handling the device. A prerequisite for safe working is the observance of all stated safety guidelines and instructions.

Furthermore the local accident prevention guidelines and general safety instructions for the application area of the device are to be adhered to.

Read the operating manual thoroughly before starting any work! It is a part of the product and has to be kept near the tool and easily accessible to the staff at all times.

If the tool is given to third parties, also include the operating manual.

The figures in this manual are for presentation purposes of facts not necessarily to scale and may slightly differ from the actual model of the device.

### 3.2 Keep the manual for future reference

The operating manual has to be available during the whole service life of the product.

### 3.3 Division

The operating manual is divided into 2 books:

- Part 1 Safety

General safety instructions mixing pumps/feed pumps

Article number: 00 17 27 09

- Part 2 Overview, operation and service (this manual).

For safe operation of the device both parts have to be read and observed. Together they form one operating manual.

### 3.4 Spare parts lists

Spare parts lists for the machine can be found on the Internet at [www.pft.eu](http://www.pft.eu).





## 4 Technical data

### 4.1 General information

Detail	Value	Unit
Weight approx.	308	kg
Length	1200	mm
Width	720	mm
Height	1530	mm

#### Individual weights

Detail	Value	Unit
Weight pump motor with tilt flange	51	kg
Weight of mixing pump module	81	kg
Weight of hopper module	162	kg
Weight compressor	14	kg

#### Hopper dimensions

Detail	Value	Unit
Filling height	910	mm
Hopper volume	145	l
Hopper capacity with attachment	200	l

### 4.2 Power connection



Fig. 1: Motor protection switch

	Power	Setting value	Designation
Star wheel	0.3 kW	0.95 A	Q4
Mixer motor	5.5 kW	11 A	Q5
Water pump	0.37 kW	2.5A	Q6
Compressor	0.52 kW	3.3A	Q6

#### Water connection

Detail	Value	Unit
Operating pressure, min.	2.5	bar
Connection	3/4	inch

### 4.3 Operating conditions

#### Environment

Detail	Value	Unit
Temperature range	2-45	°C
Relative humidity, max.	80	%

**Technical data**

**Duration**

Detail	Value	Unit
Max. operating time at a stretch	8	hours

**Electrical details**

Detail	Value	Unit
voltage, three-phase current 50 Hz	230 / 400	V
Power consumption, max.	18	A
Power input, max. approx.	7,5	kW
Fuse protection, at least (400V)	3 x 25	A
Fuse protection, at least (230V)	1 x 16	A
Speed pump motor approx.	385	rpm
Speed star wheel motor	12	rpm

## 4.4 Power values

**Pump output SD6-3 SLIMLINE**

Detail	Value	Unit
Pump capacity, approx.	17	l/min at 385 rpm
Operating pressure, max.	20	bar
Grain size max.	2	mm
Feed range *, max. at 25 mm Ø	15	m
Feed range *, max. at 35 mm Ø	20	m
Compressor output DELTA 2	0.25	Nm <sup>3</sup> /min

\* reference value depending on conveying height, pump condition and version, mortar quality, composition and consistency

## 4.5 Sound power level

Guaranteed sound power level LWA

95dB (A)

## 4.6 Vibrations

 Weighted effective value of acceleration to which the upper body parts are exposed <2.5 m/s<sup>2</sup>

## 5 Dimension sheet

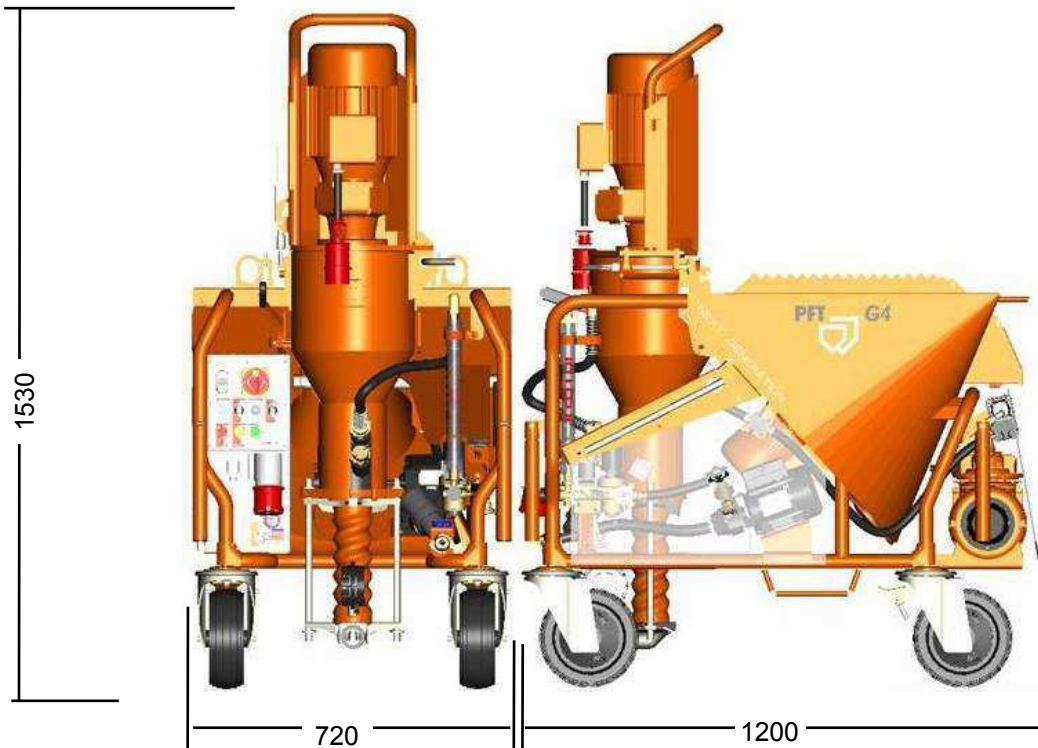

Fig. 2: Dimension sheet

## 6 Name plate

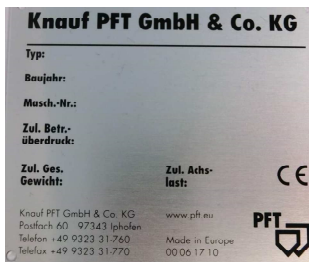

Fig. 3: Name plate

The type plate is located at the right bottom of the hopper and includes the following information:

- Manufacturer
- Type
- Year of manufacture
- Machine number
- Permissible operating pressure

## 7 Quality Control sticker



Fig. 4: Quality Control sticker

The following details can be found on the Quality Control sticker:

- CE confirmed as per EU directives
- Serial no / serial number
- Controller / signature
- Date of control

## 8 Assembly

### 8.1 Overview

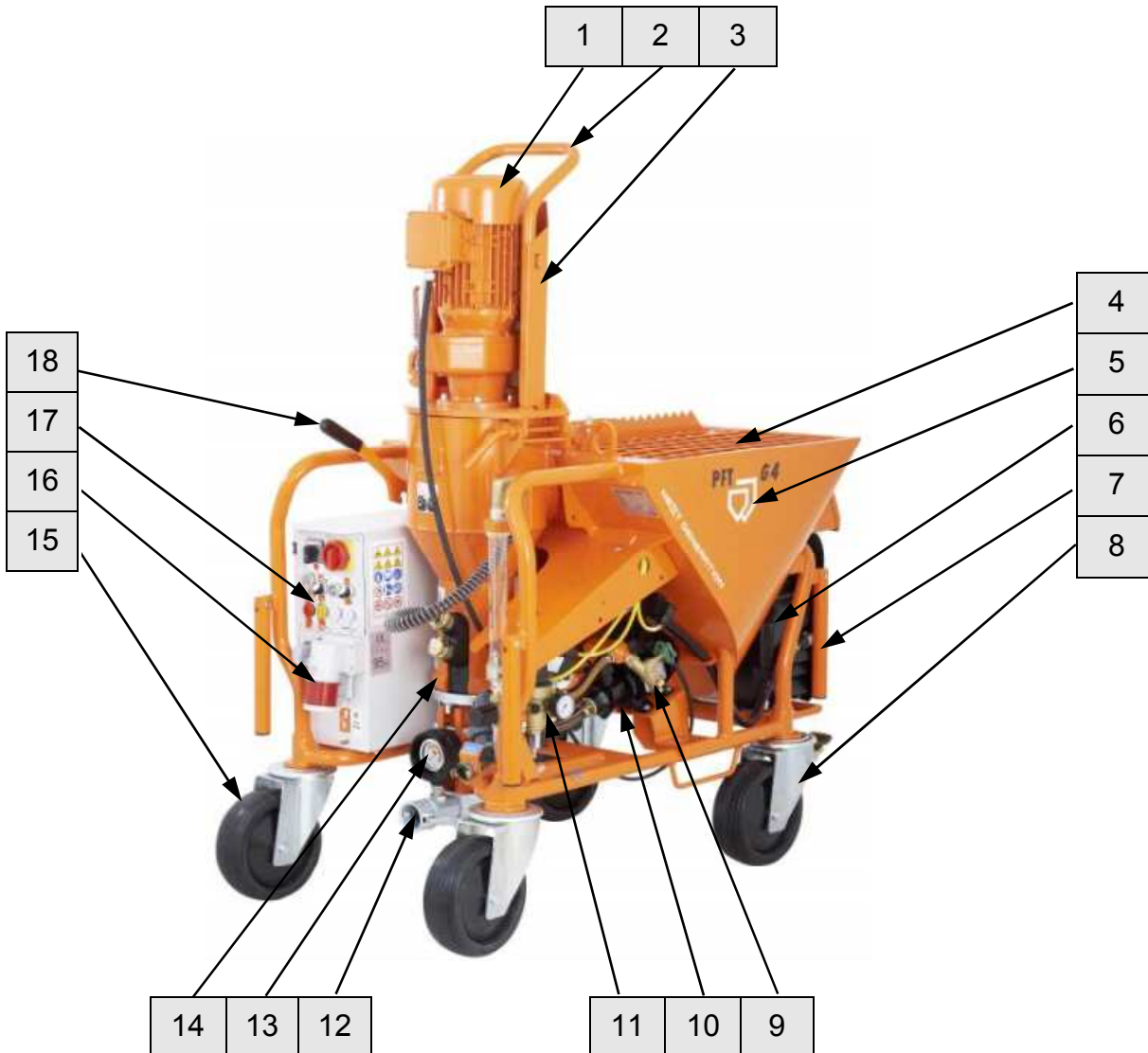

Fig. 5: Table of the assembly groups

- |                                       |                                         |
|---------------------------------------|-----------------------------------------|
| 1. Pump motor                         | 10. Booster pump                        |
| 2. Motor protection handle            | 11. Water tap                           |
| 3. Deflector plate                    | 12. Connection for mortar hose          |
| 4. Protective grille with sack opener | 13. Mortar pressure gauge               |
| 5. Hopper                             | 14. Rubber mixing section               |
| 6. Air compressor DELTA 2             | 15. Castor                              |
| 7. Carrying handle                    | 16. Power connection at control cabinet |
| 8. Double stop castor                 | 17. Control cabinet                     |
| 9. Water sampling valve               | 18. Locking lever                       |

## 9 Description of assemblies

The mixing pump PFT G 4 X consists of the following main components:

### 9.1 Hopper



- Hopper with frame and protective grille

Fig. 6: Assembly unit hopper

### 9.2 Control cabinet article number 00 25 46 51

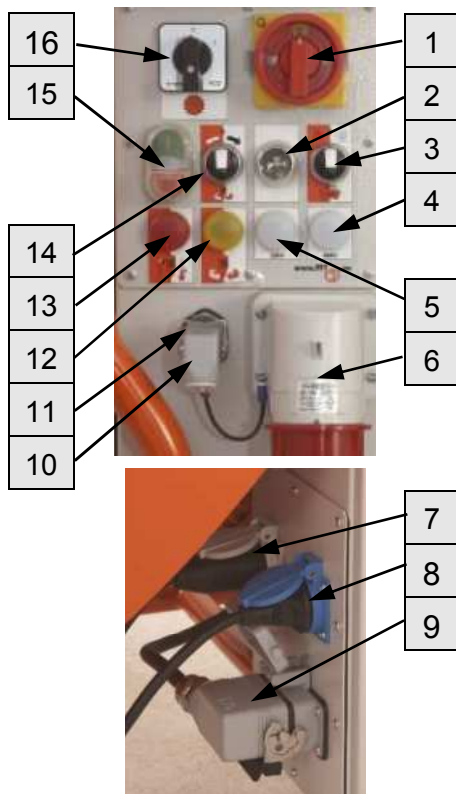

- Control cabinet
1. Master switch is also emergency-stop switch
  2. Push button water inlet
  3. Selector switch water pump manual-0-automatic
  4. Pilot lamp operation 400V
  5. Pilot lamp operation 230V
  6. Main terminal 32A
  7. \*\*Schuko socket outlet 230V, controlled for water pump
  8. Schuko socket outlet 230V, continuous current for air compressor
  9. Connection for gear motor
  10. Dummy connector for remote-controlled power socket
  11. Remote control socket.
  12. Yellow pilot lamp, for wrong direction of rotation
  13. Red pilot lamp, motor protection switch was triggered
  14. Selector switch pump motor
  15. Operation button machine ON / OFF (control voltage).
  16. Selector switch star wheel

Fig. 7: Assembly unit control cabinet



**\*\*NOTE!**

Switch off the water pump in 230V / 16 A operation. (16A fuses could trigger due to the power consumption of the machine).

### 9.3 Mixing tube with motor and pump

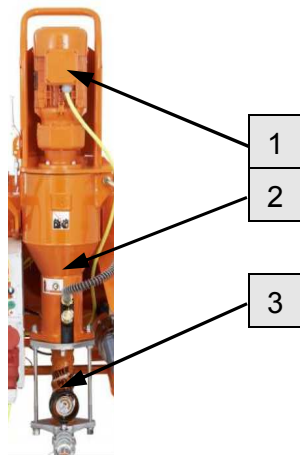

1. Pump motor 5.5kW
2. Mixing tube with rubber mixing section
3. Pump unit SD6-3 SLIMLINE

Fig. 8: Assembly unit mixing tube with motor

### 9.4 Water fitting

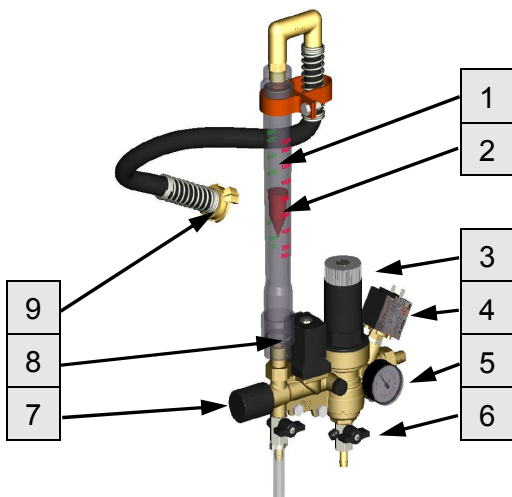

1. Water flow meter 150-1500l/h
2. The floater shows the set water factor on the scale of the plastic tube
3. The water pressure can be adjusted at the pressure reducer
4. Pressure switch water shuts down the machine in case the water pressure is too low
5. Pressure gauge water / operating pressure
6. Drain tap for frost protection
7. The required water factor is set at the needle valve
8. Solenoid valve
9. Water to mixing tube

Fig. 9: Water tap assembly

### 9.5 Air compressor DELTA2 230V with pressure switch-off



- Air compressor DELTA2 230V with pressure switch-off

Fig. 10: Air compressor

## 10 Connections

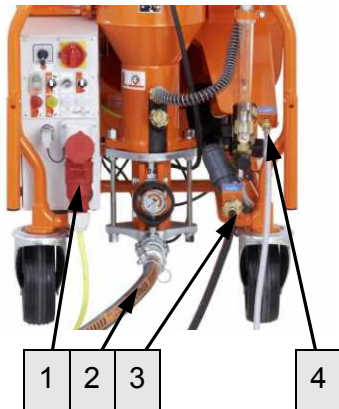

Fig. 11: Connections

1. Main terminal
2. Connections material hoses
3. Connection water supply from mains
4. Connection air to spray gun

## 11 Operating modes

### 11.1 Selector switch star wheel



Fig. 12: Operating modes star wheel

The star wheel can be operated in three operating modes:

#### **Selector switch position “0”:**

The star wheel is switched off and thus the material supply to the mixing section is interrupted, e.g. for cleaning the mixing section using the cleaning shaft or carrying out a pressure test of the pump.

#### **Selector switch position “1”:**

The star wheel is running in sync with the mixing pump motor and is switched on and off using the air control or remote control.

### 11.2 Selector switch pump motor



Fig. 13: Operating modes pump motor

The pump motor can be operated in three operating modes:

#### **Selector switch position “0”:**

The machine is switched off.

#### **Selector switch right (toggle):**

The machine starts when the main switch and the control voltage is switched on:

#### **Selector switch left 230V (momentary contact):**

The pump motor runs backwards, thus the pump is relaxed while all other functions are locked.

#### **Selector switch left 400V (momentary contact):**

Change the direction of rotation at the main switch (see chapter 28.1 taking machine into operation)

The pump motor runs backwards, thus the pump is relaxed while all other functions are locked.

### 11.3 Selector switch pressure booster pump



Fig. 14: Operating modes water pump

The booster pump can be operated in three different operating modes:

**Selector switch position “0”:**

Water pump is switched off, e.g. if the water pressure is continuously at 2.5 bar.

**Selector switch right:**

Water pump is running in sync with the mixing pump (automatic mode).

**Selector switch left:**

The water pump runs continuously in position “manual” (e.g. for cleaning the hoses).

### 11.4 Voltage 230/400V changing



Fig. 15: Voltage selector

**Voltage selector 230V / 1 phase or 400V / 3 phase**

Delivery state position of voltage selector - 400V.

Change voltage:

- Turn main switch to position "0".
- Select voltage selector 230V - 400V.
- Turn main switch to position "I".
- Press the push button control voltage "ON".

## 12 Accessories



Fig. 16: Injection hood

**PFT injection hood E1 for G 4  
(article number 20 60 02 13)**

The PFT injection hood is used for feeding dry material to the mixing pump using the PFT SILOMAT pneumatic conveying system.



Fig. 17: Delivery hood

**PFT delivery hood with off-load operation protection for G 4  
(article number 20 60 05 00)**

The PFT delivery hood is used for feeding dry material to the mixing pump PFT G 4 directly from the silo / container. In case of an empty alarm in the hopper, the mixing pump is switched off via the remote control socket.





Fig. 18: ROTOMIX

**ROTOMIX D-pumps cmpl. with 35 coupling (article number 20 11 80 00)**  
Remixer for better decomposition and mixing of the material. Direct drive via tang of the rotor. Contents approx. 1.2 l



Fig. 19: ROTOQUIRL

**ROTOQUIRL II cmpl. with 35 coupling (article number 20 11 84 00)**  
Remixer for better decomposition and mixing of the material. Direct drive via tang of the rotor. Contents approx. 4.2 l



Fig. 20: Water hose/air hose

**Water hose/air hose 3/4" x 40m with Geka couplings (article number 20 21 21 00)**



Fig. 21: Remote control cable

**Remote control cable 25m complete with ON/OFF switch and pilot lamp (article number 20 45 69 29)**



Fig. 22: Power cable

**Power cable 5 x 4 mm<sup>2</sup> 25m with CEE plug and coupling 5 x 32A 6h red (article number 20 42 39 20)**

## 12.1 Adapter cable



Fig. 23: Adapter cable

**Adapter cable reversible plug Schuko/coupling (Article number 00 22 65 38)**

Further accessories can be found at [www.pft.eu](http://www.pft.eu)

## 13 Intended use Control panel

### 13.1 Intended purpose control panel

The tool is conceptualised and designed exclusively for the purpose of use specified here.



*Scope of application:*

*Primary use for water and neutral, non-adhesive liquids. Also suitable for air and neutral non-flammable gases.*

*Maximum operating pressure (inlet pressure) 16 bar.*

*Outlet pressure infinitely adjustable from 1.5 to 6 bar.*

*Smallest possible inlet pressure 2.5 bar.*

*Minimum pressure drop (inlet pressure/outlet pressure) 1 bar.*

*Maximum media and ambient temperature 75°C.*

*Assembly position as desired, preferable vertical.*

### 13.2 Intended purpose solenoid valve



*Scope of application:*

*Solenoid valves for liquid and gaseous media, aggressive or neutral, can be used different temperature and pressure ranges*

*Type 6213 is a 2/2 way solenoid valve with straight passage, normally closed, with a permanently coupled membrane system. It operates from 0 bar and can be used universally for liquids. A minimum pressure differential of 0.5 bar is required for the valve to fully open.*

### 13.3 Intended purpose flow meter



*Scope of application:*

*The flow meter is used for the volume measurement of transparent liquid and gaseous flows in closed pipelines. Optionally the devices can be used for flow monitoring.*



### WARNING!

#### Danger due to improper use!

Any case of use beyond the specified purpose of use and/ or any other sort of use of the tool can lead to dangerous situations.

Therefore:

- Use the tool only for the purpose specified.
- Always adhere to the usage directives of the material manufacturer.
- Strictly follow all instructions in this operating manual.

Claims of any kind due to damage caused by improper use will not be entertained.

The operator of the tool is alone responsible for any damage arising from improper use.

## 14 Intended use air compressor

### 14.1 Intended purpose air compressor

The tool is conceptualised and designed exclusively for the purpose of use specified here.

A number of accessories for blowing, cleaning and compressed air tools can be connected to the compressor.

Carefully read the user manual for technical specifications and instructions for correct use.



### WARNING!

#### Danger due to improper use!

Any case of use beyond the specified purpose of use and/ or any other sort of use of the tool can lead to dangerous situations.

Therefore:

- Use the tool only for the purpose specified.
- Always adhere to the usage directives of the material manufacturer.
- Strictly follow all instructions in this operating manual.

## 14.2 Safety systems air compressor



**WARNING!**

**Danger of death due to non-functioning safety equipment!**

Safety equipment ensure highest level of safety in operation. Even if work processes become a little more complicated due to safety equipment, they must never be decommissioned. The safety is guaranteed only with intact safety equipment.

Therefore:

- Before starting work, check if the safety equipment is functioning properly and has been correctly installed.
- Use safety equipment at all times.
- Do not obstruct access to safety systems such as emergency stop buttons, pull cords etc.

## 14.3 Pressure switch-off air compressor



**WARNING!**

**Danger of death due to missing safety equipment!**

We expressly point out that the compressor must **not** be operated without pressure switch-off. External pressure switches in machines have to have the same switching cycles as the factory-set pressure switch.

If no pressure switch is positioned upstream, the compressor can be easily retrofitted.

## 14.4 Dry-running air compressor

Runs completely without oil.

**Advantage:**

High operational life, no downtime due to wear, like e.g. for a membrane compressor, as the wear of the sleeves and piston seals has a linear basis. The use of high-quality components lets the compressor reach high durability.

Multiple safety by virtue of a robust aluminium casing and sophisticated filter system. Changing filter insert for motor cooling air, easy access from the outside and easy replacement. The actual intake air for the compressor is taken in via two internal intake filters with silencer function.



## Description PFT Booster pump (Accessory)

### 15 Description PFT Booster pump (Accessory)

#### 15.1 Scope of application Booster pump

The PFT booster pump is mainly used as booster pump for interposing at the mortar mixer and mortar mixing pumps with insufficient water pressure. Moreover it can be used as suction pump to suck liquids from containers, to empty smaller pools and ponds, for cellar drainage and irrigation.

The constant water supply of the PFT machine technology is automatically ensured by means of water supply from a water reservoir by the PFT booster pump.

A flow pressure of at least 2.5 bar with the machine in operation on the construction side is guaranteed by means of suction from the water reservoir.

#### Configuration example



Fig. 24: Booster pump and water tank  
00 22 67 13 article number of booster pump  
AV1000

#### Accessories



Suction strainer with stainless steel filter screen, suction hose 1", 2.5m

art.-no. 00 13 66 19

#### 15.2 Intended use



#### Attention!

*The PFT booster pump is recommended only for pumping of clean water, of water containing a reasonable amount of impurities and non-aggressive chemical liquids. Media with fibrous and abrasive components should be avoided.*

*Their use is subject to the regulation of local legislation.*

## 16 Preparation booster pump AV3 (accessory)

### Electrical system



#### Caution!

Connect the pump only to power sockets with earthing contact. For increased safety we recommend an RCD with a GFCI switch with a rated residual current of 30 mA for the circuit to which the pump will be connected. This applies particularly when setting up the device near water tanks, ponds etc.

### Line connection



#### Caution!

It has to be ensured that the suction pipe and/or supply line

If the pump runs in suction mode, it has to be ensured that the suction line is kept as short as possible.

## 17 Initial start-up booster pump

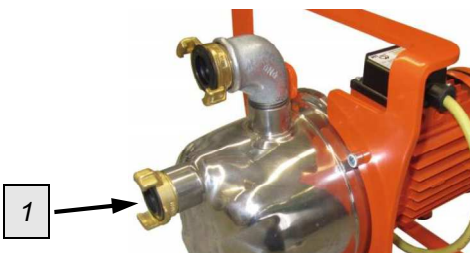

Fig. 25: Fill pump

Fill the PFT booster pump with water prior to initial start-up to let the air escape from the pump housing.

Check the strainer at the water inlet (1).

Fill water through the water inlet (1).

The filling should not be carried out too quickly to let the air escape completely from the housing.

It is best if the suction hose is also filled at that time.

### 17.1 Start-up Booster pump

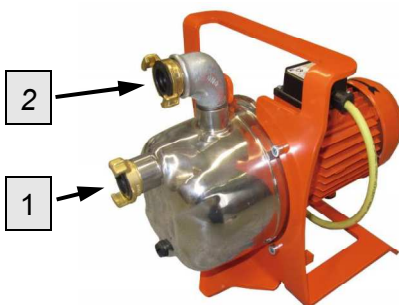

Fig. 26: Connect lines

The following instructions have to be observed before operating the pump.

The pump has to be installed in a horizontal position.

Before start-up both the suction line has to be connected to position 1 and the pressure line to position 2. It is important that the lines are of adequate dimensions:

- At least 1" for the suction line
- At least 3/4" for the pressure line

Make sure that the hose is completely airtight and immersed in the liquid to be pumped to void air being sucked in.



## Description G 4 X FU 230/400V

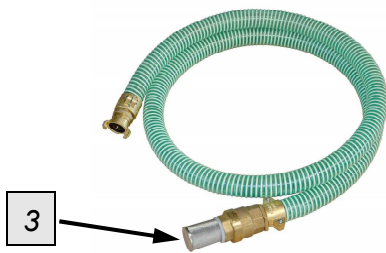

Fig. 27: Suction strainer with filter screen  
article number 00 00 69 06

The end of the suction line (3) has to be equipped with a suction strainer with filter screen and built-in non-return valve.

We recommend an additional filter for fine particles in the suction line.



### NOTE!

The flow rate of the pump decreases with increasing length of the suction line. Connect the booster pump as close as possible to the water sampling point (pressure is better than suction).

If all these points have been observed the pump can be switched on. Depending on the length of the suction line, the suction time can be up to a few seconds. If the pump does not deliver after some minutes, this might be due to the following reasons:

- There is still air in the pump and it has to be vented completely once again.
- The suction line has a leak and the pump draws air.
- The suction strainer is clogged.
- There is a kink in the suction hose.
- The maximum suction height is exceeded.



### Caution!

The pump must not run dry to avoid any damage.

## 18 Description G 4 X FU 230/400V

### 18.1 Functional principle G 4 X FU 230/400V



Fig. 28: Description

The dry section to accommodate the ready-mixed mortar is separated from the mixing and pumping section. The dry mortar is thrown into the mixing chamber via the inclined star wheel. The PFT G 4 X can be started and refilled at any time. The star wheel is powered separately and can be quickly disassembled using a central locking mechanism.

## 18.2 Functional description G 4 X FU 230/400V



Fig. 29: Functional description

The new mixing pump G 4 X with 230V AC or 400V three-phase drive was specially developed for pumping, spraying and applying of dry mortar, pasty materials for machine use and much more up to 2 mm grain size.

The pump output can be adjusted by means of a quick pump change depending on the requirements.

In 230V operation, the litre output can be set in the control cabinet via the potentiometer.

The machine can be filled with bagged material as well as directly from a silo/container by means of delivery hood or injection hood and PFT SILOMAT installation.

## 18.3 Fields of application

For pumpable pre-mixed dry mortar such as:

- |                        |                            |
|------------------------|----------------------------|
| ■ gypsum plasters      | ■ filling plasters         |
| ■ lime/gypsum plasters | ■ armour and gluing mortar |
| ■ cement plasters      | ■ floor screed             |
| ■ lime plasters        | ■ masonry mortar           |
| ■ fango material       | .... and much more         |
| ■ insulation plasters  |                            |

## 19 Material:

### 19.1 Flowability / Flow characteristics



**NOTE!**

- The pump SD6-3 can be used up to 20 bar operating pressure.
- The possible conveying distance depends mainly on the flowability of the material.
- If 20 bar operating pressure are exceeded the mortar hose length has to be reduced.
- In order to avoid machine faults and increased wear of the pump motor, pump shaft and the pump itself, only original PFT spare parts such as
  - PFT rotors
  - PFT stators
  - PFT agitators
  - PFT mortar hoses must be used.
- These are compatible with each other and form a constructive unit with the machine.
- Non-compliance does not only cause loss of guarantee, but also bad mortar quality is to be expected.



## 20 Mortar pressure gauge



### Caution!

The use of a mortar pressure gauge is recommended for safety-related reasons.



Fig. 30: Mortar pressure gauge

### PFT mortar pressure gauge

Some advantages of the mortar pressure gauge:

- Exact adjustment of the correct mortar consistency.
- Constant control of the right conveying pressure.
- Early detection of clogging or overload of the pump motor.
- Relieving pressure.
- Long service life of the PFT pump parts.
- Is a major contribution to the safety of the operators.

## 21 Safety rules



### Caution!

Observe the regional safety rules for mortar conveyors and mortar guns!

## 22 Transport, packing and storage

### 22.1 Safety instructions for transport

#### Improper transport



### ATTENTION!

#### Damage from improper transport!

Improper transport may cause substantial property damage.

Therefore:

- When unloading the packages on delivery as well as transport within the company pay attention and observe the symbols and instruction on the package.
- Use only the specified anchorage points.
- Remove packaging only shortly before the assembly.

## Suspended loads



### **WARNING!**

#### **Danger to life from suspended loads!**

When lifting heavy loads there is danger to life from falling parts or uncontrolled swinging parts.

Therefore:

- Never step under suspended loads.
- Observe the instructions regarding the provided anchorage points.
- Do not fix at projecting machine parts or eyelets of attached components and ensure safe fit of the sling gear.
- Use only approved lifting gear and sling gear with sufficient lifting capacity.

## 22.2 Transport inspection

On receipt check the delivery immediately for completeness and transport damage.

In case of externally visible transport damage, proceed as follows:

- Do not accept the delivery or under reserve only.
- Note the extent of damage on the transport documentation or on the delivery note of the carrier.
- Initiate complaint process.



### **NOTE!**

*Report any defect as soon as it is detected. Claims for damages can be asserted only within the valid warranty period.*



## 22.3 Transport

### Anchor points

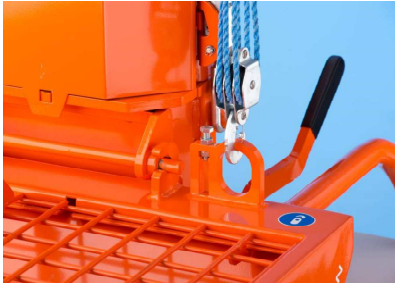

Fig. 31: Anchor points

Anchor the machine at the anchor points with a rope for transport by crane.

Observe the following conditions:

- The crane and lifting equipment have to be designed for the weight of the packages.
- The operator has to be authorised to operate the crane.

#### Attachment:

1. Anchor hooks in accordance with to both crane hooks.
2. Ensure that the package is straight, possibly observe eccentric centre of gravity.

## 22.4 Transport with van



Fig. 32: Transport

1. Remove the water hose form the mixing tube.
2. Loosen the locking lever and lift the mixing tube.
3. Insert the hook of the protective grille at the motor protection handle.
4. Lock the castors of the machine.



**DANGER!**  
**Danger of injury by unsecured loads!**

In case of road transport, all persons involved in the loading process are responsible for the proper securing of the load. The responsible driver is responsible for the operational loading.



**DANGER!**  
**Risk of injury from discharged mortar!**

Injuries to face and eyes can occur.

Therefore:

- Before opening the couplings ensure that there is no more pressure on the hoses (observe display at mortar pressure gauge).

### Transport of already running machine

1. Carry out the following steps before beginning the transport:
2. First unplug the mains cable.
3. Unplug all other cable connections.
4. Remove water supply line.
5. Remove loose parts, e.g. compressor prior to transport by crane.
6. Start transport.

## 22.5 Transport in individual parts



Fig. 33: Transport

1. Disassemble the machine in the units mixing tube and hopper for easier transport. These can be transported separately.

## 23 Packaging

### For packaging

The individual packages have to be packed in accordance with the transport conditions to be expected. Only environmentally-friendly materials were used for the packaging.

The packaging should protect the individual components until the assembly from transport damage, corrosion and other damage. Therefore do not destroy the packaging and remove only shortly before the assembly.

### Handling packaging materials

If no agreement for the recovery of the packaging has been made, separate materials according to type and size and reuse or recycle.



#### **ATTENTION!**

#### **Environmental damage due to wrong disposal!**

Packaging materials are valuable raw materials and in many cases they can be reused or reconditioned and recycled.

Therefore:

- Dispose of packaging materials in an environmentally-friendly way.
- Observe the applicable local disposal regulations. If required hand over the disposal to a specialist.

## 24 Operation

### 24.1 Safety

#### Personal protective equipment

The following protective equipment has to be worn for all operative work:

- Protective clothing
- Protective goggles
- Protective gloves
- Safety shoes
- Hearing protection



**NOTE!**

*Further protective equipment that is to be worn when effective particular jobs will be pointed out separately in the warning instructions of this chapter.*

#### Basic information



**WARNING!**

**Danger of injury due to incorrect operation!**

Improper operation may lead to serious damage to persons or property.

Therefore:

- Carry out all operating steps according to the instructions in this user manual.
- Prior to starting your work, ensure that all covers and protection devices are installed and work as intended.
- Never deactivate protection devices during operation.
- Ensure order and cleanliness in the work area! Loose components and tools on top of another or lying about pose potential accident risks.
- Increased noise level may cause permanent hearing deficiencies. At close range of the machine 95 dB(A) can be exceeded due to operational conditions. Close range is a distance of less than 5 metres to the machine.

## 25 Safety system



1

Inclination switch (1) in the terminal box of the geared motor.

- The inclination switch triggers as soon as the quick closure is opened and the geared motor is tilted on the side.
- If the machine is on rough terrain, the inclined position of the machine can also trigger the inclination switch.

Fig. 34: Safety system

## 26 Preparing the machine



Fig. 35: Grille cover



Fig. 36: Lockable castor

Prior to operating the machine carry out the following steps for preparing the machine:



### **DANGER!** **Running star wheel!**

Risk of injury when reaching into the running star wheel.

- During machine preparation and operation the grille cover (1) must not be removed.
- Never reach into the running machine.

1. Lock the lockable castor prior to operating the machine.
2. Put up the machine on a stable, even surface and secure against unwanted movements:
  - Neither tilts nor rolls off the machine.
  - Put up the machine in such a way that it cannot be hit by falling objects.
  - The operating elements have to be freely accessible.
  - Maintain a clearance of approx. 1.5 metres around the machine.

## 27 Connecting the power supply 400V

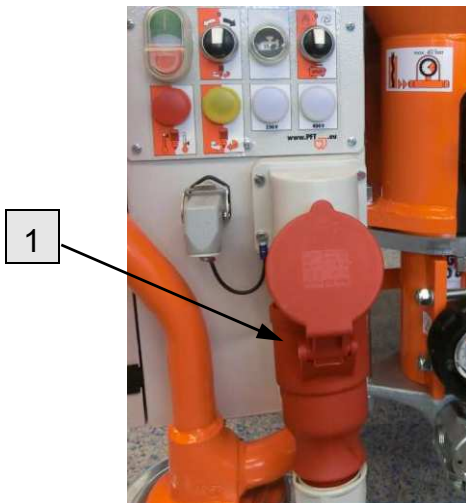

Fig. 37: Connect power supply 400V

1. Connect machine (1) to three-phase network 400V.



### **NOTE!**

The machine can be switched to 230V 1 phase and operated, although it is connected to a 400V / 3-phase supply (see page 16, fig. 15:).

**Advantage:** The motor speed can be controlled via the potentiometer.

**Disadvantage:** As the machine is controlled via the frequency converter, the gear motor no longer reaches its full capacity (maximum 4 kW).

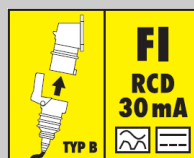

### **DANGER!** **Danger of death from electric current!**

The connection line has to be fused properly:

Connect the machine only to a power supply with permissible RCCB 30 mA RCD (residual current operated device) type "B" all-current sensitive for operation of frequency converters.



## Connecting the power supply 400V

### 27.1 Check the individual connectors

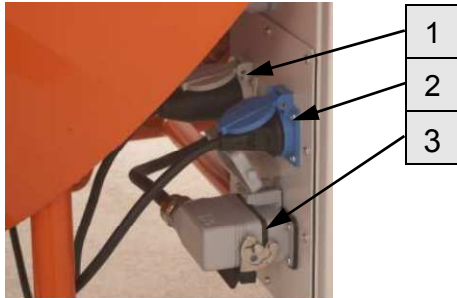

Fig. 38: Power connections

- Connection of pump motor (1).



**NOTE!**

*The booster pump is necessary should the water pressure be less than 2.5 bar when the machine is running.*

- Check connection of air compressor (2).
- Check connection of pump motor (3).



**WARNING!**

**Danger to life from rotating parts!**

Improper operation may lead to serious damage to persons or property.

- The respective drive (motors) must be operated only with the control cabinet of the machine.

### 27.2 Connecting the water supply

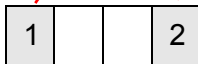

Fig. 39: Draining cocks

1. Close the water draining cocks (1) at the water fitting.
2. Close the water sampling valve (2).



Fig. 40: Connecting the water

3. Clean the water hose (3) from the water supply and bleed.
4. Connect the water hose (3) to the water inlet (4).



**NOTE!**

*Use only clean water free of solids. The minimum pressure is 2.5 bar when the machine is running.*

*Pay attention to the Drinking Water Ordinance in part 1.*

## Connecting the power supply 400V

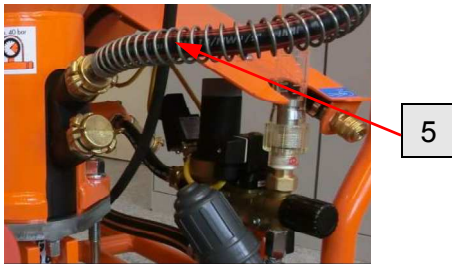

Fig. 41: Remove the water hose



**NOTE!**

*Never let the pump run dry as this reduces the service life of the pump.*

5. Remove the water hose (5) from the mixing tube.
6. Open the water tap from the water supply line.

### 27.3 Connection of water from water tank



Fig. 42: Booster pump

00 22 67 13 article number of booster pump AV1000



Fig. 43: Filter screen



**NOTE!**

*When working from the water tank, the strainer with filter screen (article number 00136619) has to be positioned upstream (bleed booster pump).*



**NOTE!**

*Never let the booster pump run dry as this reduces the service life of the pump significantly.*





## 28 Switching on the G 4 X (400V)

### 28.1 Putting the machine into operation (400V)

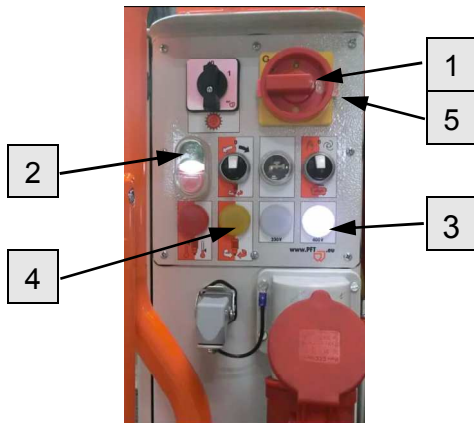

Fig. 44: Switching on

1. Turn main switch (1) to position "I".
2. Press the green push button (2) control voltage "ON" (only for 400V).
3. Pilot lamp operation 400V (3) lights up.
4. If the yellow pilot lamp "change direction of rotation" (4) lights up, change the direction of rotation.
5. Turn main switch (1) to position "0".
6. Push the metal bracket (5) in the opposite direction.
7. Turn main switch (1) to position "I".



**NOTE!**

The machine starts up only, if the yellow pilot lamp does not light up.

### 28.2 Set water quantity



Fig. 45: Water supply button

1. Press the water supply button (1) to adjust the water quantity.

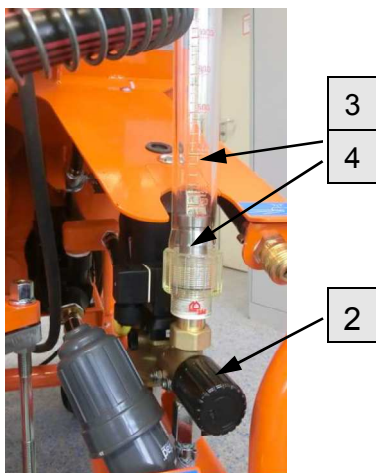

Fig. 46: Water supply button

2. At the same time adjust the expected amount of water required at the needle valve (2).
3. The water flow can be seen at the inspection glass (3) of the water flow meter and the level of the floater (4).



**NOTE!**

The specifications of the material manufacturer are to be observed here, e.g. Knauf MR75 water consumption approx. 650l/h



**NOTE!**

Any interruption of the spray operation results in a slight irregularity in the consistency of the material. This irregularity normalises by itself as soon as the machine has been working for a short while. Therefore it is important not to change the water quantity for each irregularity. Wait until the consistency of the material has set again.

## Mortar pressure gauge



### 28.3 Soaking of the mixing section



Fig. 47: Soaking



**NOTE!**

*As a rule, the pump has to be soaked. The soaking process permits an easier start-up of the pump.*

1. Connect the water hose (1) to the mixing tube.
2. Remove the blind cover (2) from the lower water nozzle.
3. Press the water supply button (3).
4. Release the water supply button (3) as soon as water emerges from the lower water nozzle.
5. Screw the blind cover (2) back on the lower water nozzle.

## 29 Mortar pressure gauge



Fig. 48: Mortar pressure gauge



**DANGER!**

**Operating pressure too high!**

Machine parts can open in an uncontrolled manner and injure the operator.

- Do not operate the machine without mortar pressure gauge.
- Use only mortar hoses with a permissible operating pressure of at least 40 bar.
- The burst pressure of the mortar hose must reach at least 2.5 times the value of the operating pressure.

## 30 Hazardous dusts

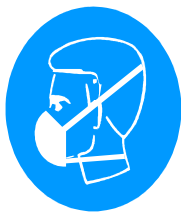

Fig. 49: Dust protection



**Warning!**

In the long term, inhaled dust can lead to lung damage or have other adverse health effects.



**NOTE!**

*The machine operator or the person working in the dusty area always have to wear a dust protection mask when filling the machine!*

*The rules of the Committee on Dangerous Substances (AGS) can be found under Technical Rules for Dangerous Substances (TRGS 559).*



### 30.1 Anti-dust unit for G 4 completely



Fig. 50: Anti-dust unit

Anti-dust unit G 4 article number 00 53 97 16.

Consisting of:

1. Anti-dust hood completely RAL2004
2. Industrial vacuum cleaner.
3. Deflector plate.
4. Set Industrial vacuum cleaner.

## 31 Feeding dry material to the machine



Fig. 51: Bagged goods

Depending on the equipment, the machine can be fed with bagged goods, with the delivery hood or the injection hood.

- Feeding with bagged goods:



**DANGER!**  
**Risk of injury at the sack opener!**

The sharp edges of the sack opener pose a risk of injury.

- Wear safety gloves.



Fig. 52: Delivery hood

Feeding with delivery hood:

- Accessory article number 20 60 05 00
- Put the delivery hood instead of the grille cover.



**DANGER!**  
**Risk of injury at the star wheel!**

Do not open the delivery hood during the operation of the machine. Before opening, turn off the master switch and interrupt the power supply.

## Monitoring the machine



Fig. 53: Injection hood

Feeding with injection hood:

- Accessory article number 20 60 02 13
- Put the delivery hood instead of the grille cover.



**DANGER!**  
**Risk of injury at the star wheel!**

Do not open the machine during pneumatic conveying. Before opening, turn off the master switch and interrupt the power supply.



**NOTE!**

*First feed material to the mixing pump G 4 X. Pull the dummy connector or switch off the machine using pressure control air. Start your work only when the level sensor indicates full.*

## 32 Monitoring the machine



**DANGER!**  
**Access by unauthorised persons!**

The machine must be operated only if monitored.



## 33 Putting the machine into operation

### 33.1 Check consistency of mortar



Fig. 54: Consistency test tube

1. Connect consistency test tube at the mortar pressure gauge.
  2. Place a bucket or pan under the consistency test tube.
- Article number: 20104301 Consistency test tube 25m piece

### 33.2 Start the machine in a “flying” mode (400V)

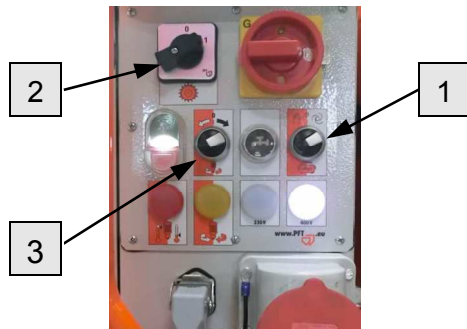

Fig. 55: Switching on

1. Turn the selector switch (1) of the booster pump clockwise.
2. Turn the selector switch (2) of the star wheel to position “I”.
3. Switch on the machine, turn the selector switch of the pump motor (3) clockwise.



Fig. 56: Consistency of mortar

4. Check consistency of mortar.



Fig. 57: Switching off

5. Switch off the machine at selector switch (position “0”).
6. Remove consistency test tube and clean it.

## 34 Mortar hoses

### 34.1 Prepare mortar hoses

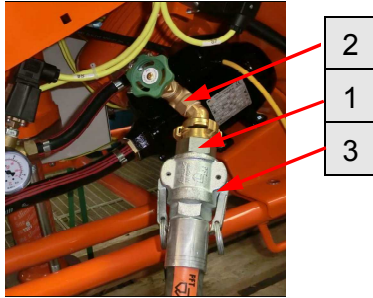

Fig. 58: Prepare mortar hose

1. Connect the cleaner coupling (1) at the water extraction valve (2).
2. Connect the mortar hose (3) at the cleaner coupling.
3. Open the water sampling valve (2) and water the mortar hoses.
4. More mortar hose and cleaner coupling again and separate.
5. Remove all the water from the mortar hose.
6. Pre-lubricate the mortar hose with about two litres of wallpaper paste.
7. The wallpaper paste is mixed through the mortar hose with the first mixing.



**DANGER!**

Never loosen the hose couplings as long as there is pressure on the mortar hoses (check mortar pressure gauge)! The mix could burst out under pressure and result in serious injuries, especially injuries to the eyes.

Torn off hoses can beat about and injure bystanders!

### 34.2 Connect mortar hose

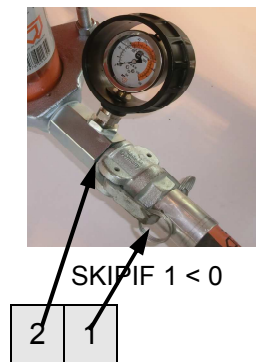

Fig. 59: Connect mortar hose

1. Connect mortar hose (1) to the pressure flange (2).

**NOTE!**



*Ensure clean and correct connection and tightness of the couplings! Dirty couplings and rubber seals are not watertight, and water might leak under pressure inevitably leading to blockages.*

2. Lay mortar hoses in large radius so that no kinks form in the hoses.
3. Attach risers carefully in order to prevent them from tearing off under their own weight.
4. Switch on the machine, turn the selector switch of the pump motor (3) clockwise.
5. As soon as mortar emerges at the end of the mortar hose, switch off the machine at the selector switch for the pump motor (3) (Position "0").



Fig. 60: Switching on

## 35 Compressed air supply

### 35.1 Connect air hose



1. Connect compressed air hose (1) at the air fitting.



**DANGER!**

Never loosen the hose couplings as long as the compressed air hose is not depressurised.

Fig. 61: Connect air hose

### 35.2 Connecting the spraying gun

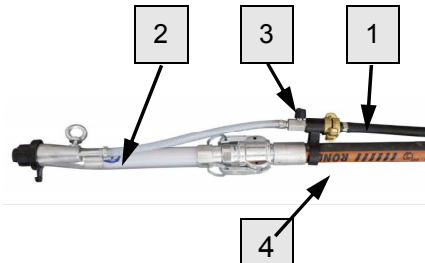

1. Connect the compressed air hose (1) at the spraying gun (2).
2. Ensure that the air tap (3) is connected to the spraying gun.
3. Connect the spraying gun (2) at the mortar hose (4).

Fig. 62: Spraying gun

### 35.3 Switch on air compressor



1. Switch on the air compressor using the green toggle switch (1).
2. As soon as the air compressor has built up pressure in the pipeline system, it switches off using the pressure switch-off.

Fig. 63: Air compressor

## 36 Apply mortar



### **DANGER!** **Risk of injury from discharged mortar!**

Discharged mortar may lead to injuries to eyes and face.

- Never look into the spraying device.
- Always wear protective goggles.
- Always position yourself in such a way that you are not hit by the mortar being discharged.



### **NOTE!**

*The possible conveying distance depends mainly on the flowability of the mortar. Heavy, sharp-edged mortar has poor flow characteristics. Runny materials have good flow characteristics.*

*If 20 bar operating pressure are exceeded thicker mortar hoses have to be used.*

### 36.1 Open the air tap at the spraying gun



Fig. 64: Switching on

1

1. Turn the selector switch of the pump motor (1) clockwise.
2. Aim the spray gun at the wall to be plastered.
3. Ensure that nobody is in the discharge area of the mortar.
4. Open the air tap (2) at the spraying gun.
5. The machine will start-up automatically via the pressure switch-off and the mortar emerges.



Fig. 65: Opening the air tap

2



### **NOTE!**

*The correct mortar consistency is reached, if the material mixes on the surface to be sprayed (we recommend application on wall surfaces from top to bottom). If the water quantity is too little even mixing and spraying is no longer guaranteed; blockages may form inside the hose and high wear of the pump parts will become an issue.*



### **NOTE!**

*It is also possible to operate the machine without compressed air, e.g. for pumping screed. Switch off the compressor at the red switch.*

*Connect the remote control (see chapter 37 remote control) and use it to switch on/switch off the machine.*



### 36.2 Interruption of work



**NOTE!**

Always observe the setting time of the material to be processed:

Clean the system and mortar hoses depending on the setting time of the material and the length of the interruption (pay attention to outside temperature).

The guidelines of the material manufacturers have to be observed regarding breaks.

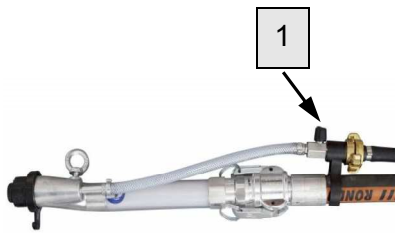

Fig. 66: Closing the air tap

1. Close the air tap (1) if you interrupt your work for a short while.
2. The machine stops.
3. Once you open the air tap (1), the machine will start-up again.

### 36.3 In case of longer interruption of work/break

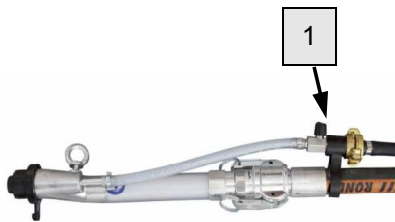

Fig. 67: Closing the air tap

1. Close air tap (1).



Fig. 68: Switching off

2. Switch off the machine at selector switch of the pump motor (2) (position "0").

### 36.4 Switch off air compressor



Fig. 69: Air compressor

1. Switch off the air compressor using the green toggle switch (1).
2. Open the air tap at the spraying gun.



**DANGER!**  
**Risk of injury from discharged mortar!**

Discharged mortar may lead to injuries to eyes and face.

➤ Attention, residual pressure.

## 37 Remote control

### 37.1 Working with the remote control

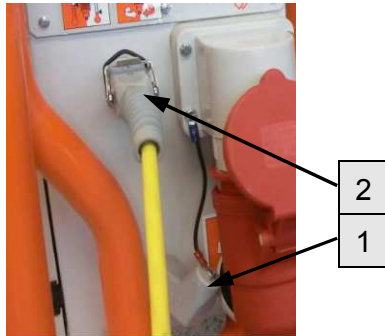

1. Remove dummy connector (1) from control cabinet.
2. Connect remote control (2).
3. The G 4 X can be switched on or off using the remote control.

Fig. 70: Remote control

## 38 Stopping in case of emergency Emergency-stop switch

### 38.1 Emergency-stop switch

#### Stopping in case of emergency



Fig. 71: Stopping

In dangerous situation machine movements have to be stopped as quickly as possible, and the power supply has to be disconnected.

In case of danger proceed as follows:

1. Turn the main switch to position "0".
2. Secure the main switch against reactivation.
3. Inform responsible person at the operational site.
4. If necessary call for medical assistance and fire brigade.
5. Recover persons from the danger zone, initiate First Aid measures.
6. Keep access routes free for emergency vehicles.
7. If the severity of the emergency permits inform the competent authorities.
8. Assign specialised personnel with the troubleshooting.

#### After the rescue operations



**WARNING!**  
**Danger to life from premature reactivation!**  
 On reactivation there is danger to life for all persons in the danger zone.

- Before reactivation ensure that there are no persons in the danger zone anymore.

9. Check the system before reactivation and ensure that all safety equipment is installed and functional.



## 39 Measures in case of power cut

### 39.1 Main switch to position "0"



Fig. 72: Selector switch position "0"

1. Close the air tap at the spraying gun.
2. Turn the main switch (1) to position "0".
3. Turn the selector switch for the pump motor (2) to position "0".
4. Switch off the air compressor using the green toggle switch.
5. Let qualified personnel check the power supply.

### 39.2 Relieve mortar pressure

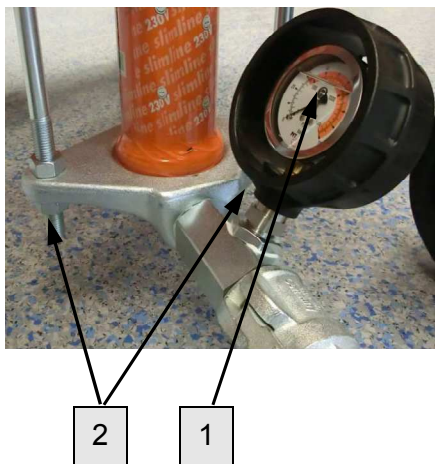

Fig. 73: Check mortar pressure



**DANGER!**  
**Overpressure on the machine!**

When opening machine parts they can open in an uncontrolled manner and injure the operator.

- Open machine only when the pressure is at "0 bar".



**DANGER!**  
**Risk of injury from discharged mortar!**

Discharged mortar may lead to injuries to eyes and face.

Therefore:

- Never look into the spraying device.
- Always wear protective goggles.
- Always position yourself in such a way that you are not hit by the mortar being discharged.

1. Open the air tap at the spraying gun.
2. Check the mortar pressure gauge (1) if the mortar pressure has lowered to "0 bar". If required relieve the mortar pressure by lightly loosening the nuts (2). In doing so, cover the work area with film.
3. Firmly tighten the nuts again.
4. Close the air tap at the spraying gun.

## Work on troubleshooting



Fig. 74: Power failure



**NOTE!**

*The G 4 X is equipped with a restart interlock. In case of a power cut, the system has to be started as follows.*

5. Turn main switch (3) to position "I".
6. Press the green push button (4) control voltage "ON".
7. Switch on the air compressor using the green toggle switch.
8. Switch on the machine, turn the selector switch of the pump motor (5) clockwise.
9. The G 4 X starts again as soon as the air tap at the spray gun is opened again.



**NOTE!**

*In case of a longer power cut, the G 4 X and the material hoses have to be cleaned immediately.*

## 40 Work on troubleshooting

### 40.1 Reaction in the event of faults

The following strictly applies:

1. In the event of faults presenting immediate danger to persons or property, activate the emergency off function immediately (switch off main switch).
2. Determine cause for fault.
3. If the rectification of faults requires works in the danger zone, switch off the system and secure against restarting.
4. Inform the manager on site immediately about the fault.
5. Depending on the type of fault commission authorised skilled personnel or rectify the fault yourself.



**NOTE!**

*The following fault table gives information on who is authorised to rectify the fault.*

## 40.2 Fault displays

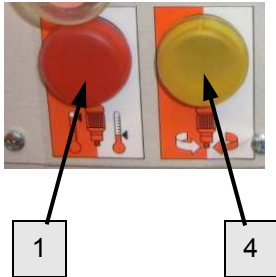

Fig. 75: Fault displays

The following installation indicates faults:

Pos.	Light signal	Description
1	Red pilot lamp	Lights up on motor protection switch fault. Check motor protection switch
2	Yellow pilot lamp	Lights up if the direction of rotation is wrong (400V).

## 40.3 Faults

The following chapter describes possible causes for faults and the activities carried out for their rectification.

In case faults occur frequently, shorten the maintenance intervals in accordance with the actual load.

In the event of faults that cannot be rectified by means of the following notes, kindly contact the dealer.

## 40.4 Safety

### Protective gear

The following protective equipment has to be worn for all maintenance work:

- Protective clothing.
- Protective goggles, protective gloves, safety shoes, ear protection.

### Personnel

- The work for rectification of faults described here can be carried out by the operator, unless marked otherwise.
- Some works must be carried out only by specially trained skilled personnel or exclusively by the manufacturer. Information on this can be found in the description of the individual faults.
- Work on the electrical system must, in principle, be carried out only by electricians.

**Work on troubleshooting**

**40.5 Table of faults**

<b>Fault</b>	<b>Possible cause</b>	<b>Solution</b>	<b>Rectification by</b>
Machine does not start <b>water</b>	Water pressure too low	Check water supply, clean strainer screen	Operator/Service engineer
	Pressure gauge shows less than 2.2 bar	Check booster pump	Service engineer
Machine does not start <b>power</b>	Power supply not in order	Repair power supply	Service engineer
	Main switch not activated	Activate main switch	Operator
	RCCB was triggered	Reset RCCB	Service engineer
	Yellow pilot light, fault direction of rotation lights up	Push the metal bracket at the main switch in the opposite direction	Operator
	Motor protection switch triggered	Turn motor protection switch in control cabinet to position 1	Service engineer
	Operating button "ON" not pressed	Press operating button "ON"	Operator
	Contactors defective	Change contactors	Service engineer
Machine does not start <b>air</b>	Insufficient drop in pressure in the remote control due to blocked air duct or air nozzle pipe	Clean blocked air duct or air nozzle pipe	Operator
	Air safety switch set wrongly	Set air safety switch	Service engineer
	Air compressor not switched on	Switch on air compressor	Operator
Machine does not start <b>material</b>	Too much thickened material in hopper or mixing section	Empty half of the hopper and start again	Operator
	Excessively dry material in pump part	Run the machine in backward mode, otherwise remove pump and clean it	Operator
Water does not run (flow meter does not show anything)	Solenoid valve (hole in membrane blocked)	Clean solenoid valve	Service engineer
	Solenoid coil defective	Change solenoid coil	Service engineer
	Pressure reducing valve closed	Open pressure reducing valve	Operator
	Water inlet at pump tube blocked	Clean water inlet at pump tube	Operator
	Needle valve closed	Open needle valve	Operator
	Cable to solenoid valve defective	Replace cable to solenoid valve	Service engineer



**Work on troubleshooting**

<b>Fault</b>	<b>Possible cause</b>	<b>Solution</b>	<b>Rectification by</b>
Pump motor does not start	Pump motor defective	Exchange pump motor	Service engineer
	Connection cable defective	Change connection cable	Service engineer
	Plug or inbuilt socket defective	Change plug or inbuilt socket	Service engineer
	Motor protection switch defective or triggered	Change motor protection switch or reset	Service engineer
Machine stops after a short while	Strainer screen contaminated	Clean or replace strainer	Operator
	Strainer sieve of pressure relieve	Clean or replace strainer	Operator
	Hose connection or water pipe too small	Increase dimensions of hose connection or water pipe	Operator
	Booster pump not switched on	Switch on booster pump	Operator
Machine does not switch off	Air pressure safety switch set incorrectly or defective	Adjust or replace air pressure safety switch	Service engineer
	Air pressure hose defective or seals defective	Replace air pressure hose, replace seals or check compressor	Service engineer
	Air tap at the spraying gun	Replace air tap	Service engineer
	Power provided by compressor is too low.	Check compressor	Service engineer
	Air duct is not connected to the compressor	Connect air duct to the compressor	Operator
Mortar flow "thick-thin"	Too little water	Increase the water quantity by 10% for approx. ½ minute and then turn down slowly	Operator
	Water safety switch set incorrectly or defective	Adjust or replace water safety switch	Service engineer
	Agitator defective; no original PFT agitator	Replace agitator with original PFT agitator	Operator
	Pressure reducer set incorrectly or defective	Adjust or replace pressure reducer	Service engineer
	Rotor worn or defective	Replace rotor	Service engineer
	Stator worn or clamping bracket tightened too little	Replace stator or re-tighten clamping bracket	Service engineer
	Clamping bracket defective (oval)	Replace clamping bracket	Service engineer
	Inner wall of mortar hose defective	Replace mortar hose	Operator
	Rotor too deep in pressure flange	Replace pressure flange	Service engineer
No original PFT spare parts	Use original PFT spare parts	Service engineer	

**Work on troubleshooting**



<b>Fault</b>	<b>Possible cause</b>	<b>Solution</b>	<b>Rectification by</b>
Mortar flow ceases (air bubbles)	Bad mixture in mixing tube	Add more water	Operator
	Material is clumped and narrows the mixing tube inlet	Add more water or clean agitator or replace	Operator
	Material in mixing tube has become wet	Empty mixing tube, dry it and start again	Operator
	Agitator defective	Replace agitator	Operator
	Driving dog defective	Replace driving dog	Service engineer
During operation water rises in the mixing tube	Backpressure in mortar hose higher than pump pressure	Retighten or replace stator	Service engineer
	Rotor or stator worn	Replace rotor or stator	Service engineer
	Hose is blocked by mortar that is too thick (high pressure by low water factor)	Remove blockage, increase water factor	Service engineer
Red pilot lamp, fault lights up	Overload due to the pump getting blocked with dry material	Run the machine in backward mode, otherwise remove pump and clean it	Service engineer
	Overload due to low water volume	Increase water feed on startup	Operator
	Motor protection switch pump motor (16 A) triggered	Reactivate protection switch	Service engineer
	Overload due to compacted material in hopper	Clean hopper Reactivate protection switch	Service engineer

**40.6 Signs for hose blockages:**

- Implementation by operator:
- Blockages can occur in the pressure flange or in the mortar hoses.
- Indications are:
  - rapidly increasing pressure head,
  - blocking of pump,
  - running difficulties or blockage of the pump motor,
  - expansion and turning of the mortar hose,
  - no material discharge at the hose end.





### 40.7 Causes for this can be:

- Highly worn mortar hoses,
- badly greased mortar hoses,
- residual water in mortar hose,
- clogging of the pressure flange,
- strong tapering at the couplings,
- kink in mortar hose,
- leaks at the couplings,
- badly pumpable and demixed materials.

### 40.8 Earlier damage to the mortar hose



#### NOTE!

If in the event of a machine fault by material clogging the pressure in the mortar hose exceeds 60 bar, even only temporarily, replacement of the mortar hose is recommended as there might be damage in the hose that is not externally visible.

## 41 Removal of blockages in the hose



#### DANGER!

#### Danger from discharged material!

Never loosen the hose couplings as long as the pressure head is reduced! Material to be conveyed can be discharged under pressure and cause injuries particularly to the eyes.

Persons commissioned with the cleaning of clogged hoses have to wear personal protective equipment (protective goggles, gloves) for safety reasons, and to position themselves in such a way that they cannot be hit by discharged material. Other persons have to clear the area.

### 41.1 Change the direction of rotation of the mixing pump motor in case of blockages in the hose (400V)

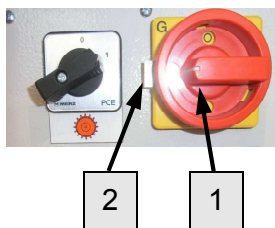

1. Turn the main switch (1) to position "0".
2. Switch off the air compressor using the green toggle switch.
3. Push the metal bracket (2) in the opposite direction.

Fig. 76: Change direction of rotation  
400V

## Removal of blockages in the hose

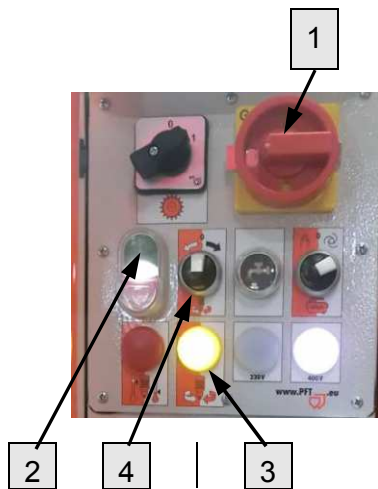

Fig. 77: Change direction of rotation

1. Turn main switch (1) to position "1".
2. Press the green push button (2) control voltage "ON".
3. The yellow pilot lamp (3) for changing the direction of rotation lights up (400V).
4. Turn selector switch of the pump motor (4) briefly anti-clockwise, until the pressure at the mortar pressure gauge has dropped to "0 bar".
5. Turn the selector switch for the pump motor (4) to position "0".
6. Turn the main switch (1) to position "0".

### 41.2 Change the direction of rotation of the mixing pump motor in case of blockages in the hose (230V)

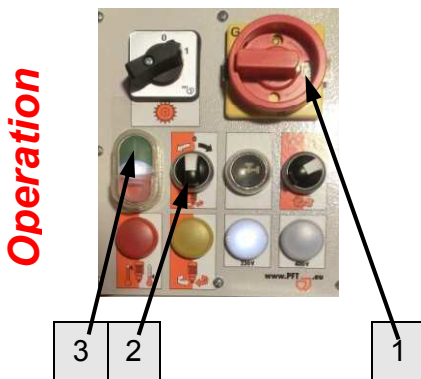

Fig. 78: Change direction of rotation 230V

1. Turn the main switch (1) to position "0".
2. Turn the selector switch for the pump motor (2) to position "0".
3. Switch off the air compressor using the green toggle switch.
4. Turn main switch (1) to position "1".
5. Press the green push button (3) control voltage "ON".
6. Turn selector switch of the pump motor (2) briefly anti-clockwise, until the pressure at the mortar pressure gauge has dropped to "0 bar".
7. Turn the selector switch for the pump motor (2) to position "0".
8. Turn the main switch (1) to position "0".

### 41.3 Blockage does not dislodge

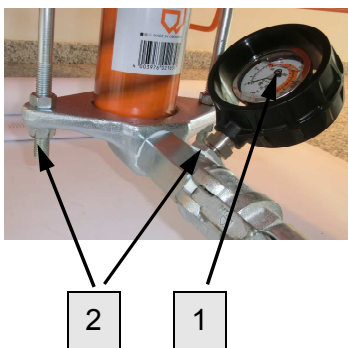

Fig. 79: Mortar pressure gauge



#### DANGER!

#### Overpressure on the machine!

When opening machine parts they can open in an uncontrolled manner and injure the operator.

- Open the mortar hoses only when the pressure at the mortar pressure gauge (1) has dropped to "0 bar".

1. Slightly loosen both nuts (2) at the tie rod so that the remaining pressure can escape completely.
2. As soon as the pressure is down to "0 bar", tighten the nuts (2) again.



## Removal of blockages in the hose

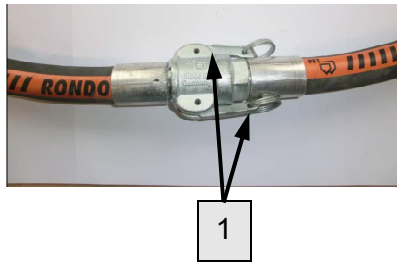

Fig. 80: Loosen coupling



**NOTE!**

Clean mortar hoses immediately

1. Cover coupling connections with tear-proof film.
2. Loosen cam leaver (1) and hose connections.
3. Dislodge the blockage by tapping or shaking at the place where the blockage is located.
4. If required, insert a rinsing hose into the mortar hose and flush out the material (PFT rinsing hose art. no. 00113856).

### 41.4 Switch the machine back on after the blockage has been removed (400V)

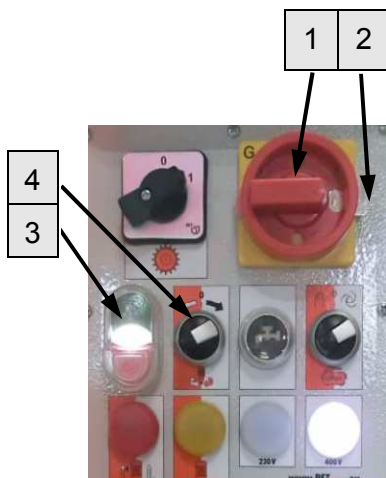

Fig. 81: Switching on

1. With the main switch (1) in position "0", push the metal bracket (2) into the opposite direction.
2. Turn main switch (1) to position "I".
3. Press the green push button (3) control voltage "ON".
4. Close the air tap at the spraying gun.
5. Switch on the air compressor using the green toggle switch.
6. Turn the selector switch of the pump motor (4) clockwise.
7. Let the machine run for a short while without mortar hoses.
8. As soon as mortar emerges at the end of the mortar hose, switch off the machine at the selector switch for the pump motor (4) (Position "0").
9. Apply wallpaper paste to the cleaned mortar hoses and connect to the machine and spray gun.
10. Turn selector switch for the pump motor (1) clockwise, open air tap at the spraying gun as described in chapter 36.1.

### 41.5 Switch the machine back on after the blockage has been removed (230V)

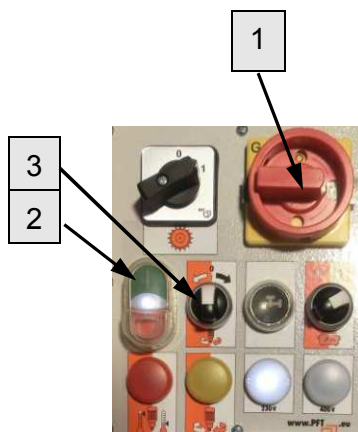

Fig. 82: Switching on

1. With the machine switched off, turn the main switch (1) to position "I".
2. Press the green push button (2) control voltage "ON".
3. Close the air tap at the spraying gun
4. Switch on the air compressor using the green toggle switch.
5. Turn the selector switch of the pump motor (3) clockwise.
6. Let the machine run for a short while without mortar hoses.
7. As soon as mortar emerges at the end of the mortar hose, switch off the machine at the selector switch for the pump motor (3) (position "0").
8. Apply wallpaper paste to the cleaned mortar hoses and connect to the machine and spray gun.
9. Turn selector switch for the pump motor (3) clockwise, open air tap at the spraying gun as described in chapter 36.1.

## Connection of power supply (230V)

### 42 Connection of power supply (230V)

#### 42.1 Voltage 230V

Operation

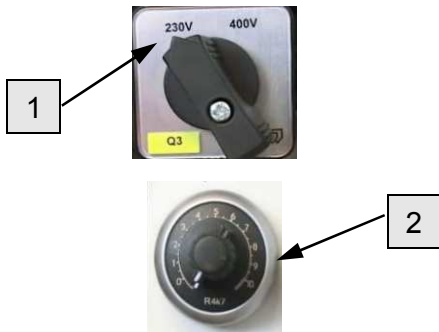

1. Open control cabinet and turn voltage selector to 230V.
2. Turn the potentiometer (2) for the motor speed and/or the material quantity to level 10.
3. Close again the control cabinet.

Fig. 83: Voltage selector

### 43 Connecting the power supply 230V

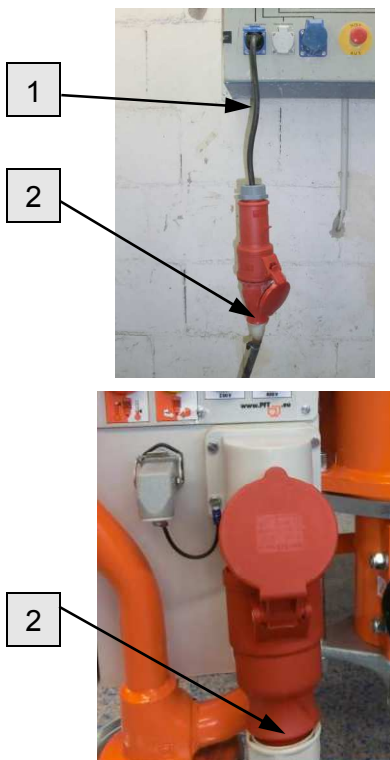
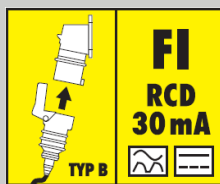

Fig. 84: Connect power 230V

1. Connect adapter cable (1) to 230V AC network.



**DANGER!**  
**Danger of death from electric current!**

The connection line has to be fused properly:

Connect the machine only to a power supply with permissible RCCB 30 mA RCD (residual current operated device) type "B" all-current sensitive for operation of frequency converters.

2. Connect the adapter cable (1) with the power cable (2) item number 20423920 and connect to the machine.



**Advantage:** The motor speed can be controlled via the potentiometer.

**Disadvantage:** As the machine is controlled via the frequency converter, the gear motor no longer reaches its full capacity (maximum 4 kW).



**NOTE!**

Further procedure as from check of the individual connectors chapter 27.1.

**NOTE!**



To ensure smooth running of the machine it has to be ensured that the adapter cable is connected on the mains side (see fig. 84).

## 44 Switching on (230V)

### 44.1 Putting the machine into operation (230V)

**Operation**

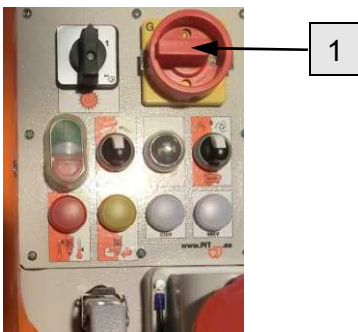

1. Turn main switch (1) to position "I".

**NOTE!**



Further procedure as from "Set water quantity" chapter 28.2.

Fig. 85: Putting the machine into operation

## 45 Start the machine in a "flying" mode 230V

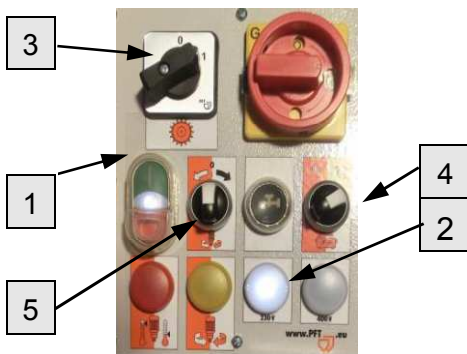

1. Press the green push button (1) control voltage "ON".
2. Pilot lamp operation 230V (2) lights up.
3. Turn the selector switch (3) for the star wheel to the right.
4. Turn the selector switch (4) of the booster pump clockwise.
5. Switch on the machine, turn the selector switch of the pump motor (5) clockwise.

**NOTE!**



Further procedure as from "Start the machine in a "flying" mode, check material consistency" chapter 33.2.

Fig. 86: Start the machine in a "flying" mode 230V

## 46 Cleaning the machine after work

### 46.1 Empty the mixing tube



Fig. 87: Switch of star wheel



Fig. 88: Switching off

The machine has to be cleaned daily after work:

1. Shortly before finishing your work turn the selector switch of the star wheel to position "0".
2. The star wheel is switched off and thus the material supply to the mixing section is interrupted, e.g. for cleaning the mixing section using the cleaning shaft or carrying out a pressure test of the pump.
1. As soon as thinner material emerges from the spraying gun, close the ball valve at the spraying gun.
2. Machine does not switch off.
3. Switch off the machine at selector switch (position "0").
4. Switch off the air compressor using the green toggle switch.
5. Open the air tap at the spraying gun.



**DANGER!**  
**Risk of injury from discharged mortar!**

Discharged mortar may lead to injuries to eyes and face.

- Attention, residual pressure.

### 46.2 Secure against restarting



**DANGER!**  
**Danger to life from unauthorised restarting!**

When working with the machine there is the risk that the energy supply is switched on without authorisation. This poses a danger to life for the persons in danger area.

- Switch off all power supplies before starting any work and secure against restarting.
- If protective covers have been removed for cleaning purposes, they must be properly put back again without fail after completion.

### 46.3 Cleaning the G 4 X



**ATTENTION!**  
**Water can enter sensitive machine parts!**

- Before cleaning the machine cover all openings in which no water must enter for safety and functional reasons (e.g. electric motors and control cabinets).



**NOTE!**

*Do not direct the water jet on electrical parts, such as gear motor or control cabinet.*

### 46.4 Decouple mortar hose

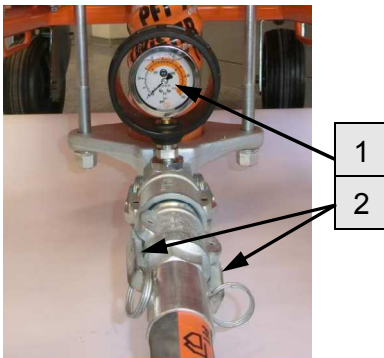

Fig. 89: Mortar pressure to "0" bar.

1. Check at the mortar pressure gauge (1) if the mortar pressure is at "0 bar".



**DANGER!**  
**Overpressure on the machine!**

When opening machine parts they can open in an uncontrolled manner and injure the operator.

- Open machine only when the pressure is at "0 bar".

2. Loosen the cam lever (2) and decouple the mortar hose from the mortar pressure gauge.

### 46.5 Clean mortar hose

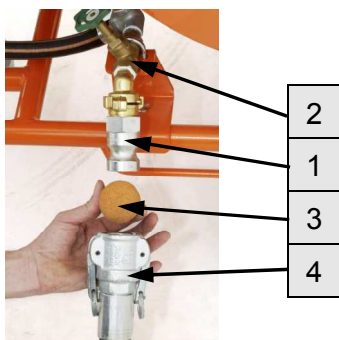

Fig. 90: Clean mortar hose



**NOTE!**

*Mortar hoses and spraying device have to be cleaned immediately after finishing work.*

1. Connect the cleaner coupling (1) at the water extraction valve (2).
2. Press the water saturated sponge ball (3) into the mortar hose (4).
3. Connect the mortar hose (4) with the sponge ball to the cleaner coupling (1).

## Cleaning the machine after work

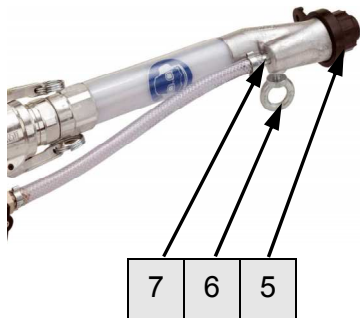

Fig. 91: Air nozzle tube and fine plaster spraying nozzle

4. Remove the fine plaster spraying nozzle (5) from the spraying gun.
5. Loosen the ring screw (6) and pull the air nozzle tube (7) out of the spray head.
6. Water sampling valve pos. 2 fig. 90 until the sponge ball emerges from the fine plaster spraying nozzle. Repeat this process until the hose is clean.
7. In case of different hose diameters, the mortar hoses have to be cleaned separately with the matching sponge balls.
8. In case of strong soiling repeat this process.
9. Clear the air nozzle tube (7) using a round file.
10. Switch on the compressor and purge the air nozzle tube.
11. Reassemble the spraying gun.

### 46.6 Remove the water hose

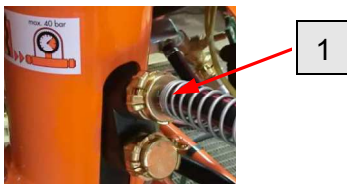

Fig. 92: Water hose

1. Remove the water hose (1) from the mixing tube.

### 46.7 Cleaning the mixing tube

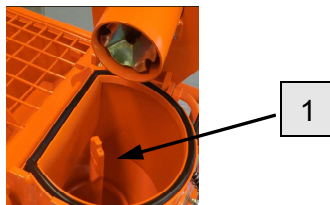

Fig. 93: Open motor tilt flange

1. Open the quick closure at the motor tilt flange and tilt the motor.
2. Remove the mixing shaft (1) and clean it.

### 46.8 Insert the mixing tube cleaner

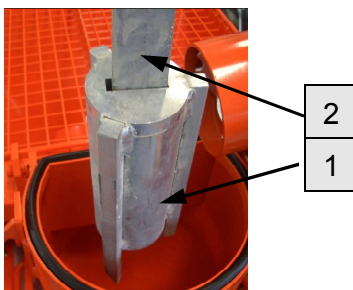

Fig. 94: Insert the mixing tube cleaner

1. Take the mixing tube cleaner (1) and cleaning shaft (2) from the tool box.
2. Insert the mixing tube cleaner (1) into the mixing tube with the scrapers pointing downward.



**NOTE!**

When inserting the cleaner shaft ensure that the cleaner shaft engages correctly in the drive dog in the head of the rotor and when closing the motor flange.





### 46.9 Close motor tilt flange

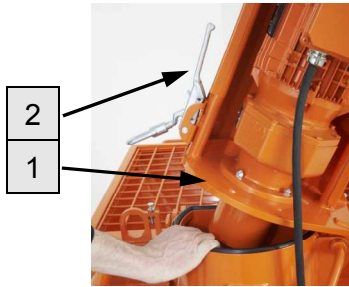

Fig. 95: Close motor tilt flange



**DANGER!**  
**Risk of contusion at the motor tilt flange!**

There is a risk of contusion when closing the motor tilt flange.

- Do not reach into the clamping area of the motor tilt flange.

1. Close the motor tilt flange (1) and lock using the quick closure (2).

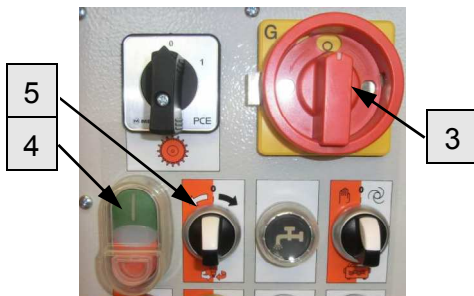

Fig. 96: Switching on

2. Turn main switch (3) to position "I".
3. Press the green push button (4) control voltage "ON".
4. Switch on the machine, turn the selector switch of the pump motor (5) clockwise.
5. Let the machine run for about 5 - 10 seconds until the mixing tube has been cleaned.
6. Switch off the machine at the selector switch of the pump motor (5) (position "0").
7. Turn main switch (3) to position "0".

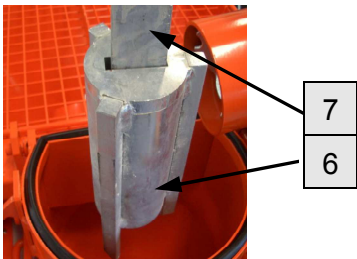

Fig. 97: Remove the mixing tube cleaner

8. Open the quick closure at the motor tilt flange and tilt the motor.
9. Take the mixing tube cleaner (6) and cleaning shaft (7) from the mixing tube.

### 46.10 Insert agitator

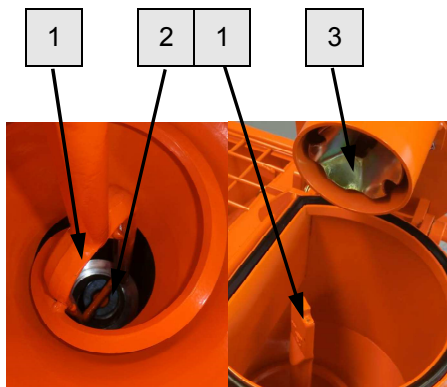

Fig. 98: Insert agitator

1. Insert agitator (1) and ensure correct positioning at the rotor head (2).
2. When closing the tilt flange ensure that the agitator (1) engages properly into the drive dog (3).
3. Close the quick closure at the mixing tube.

## 46.11 Cleaning the hopper

- The inside of the hopper can be cleaned with a water hose after having been emptied completely.

## 47 Changing the pump / Cleaning the pump

### 47.1 Fold up mixing tube

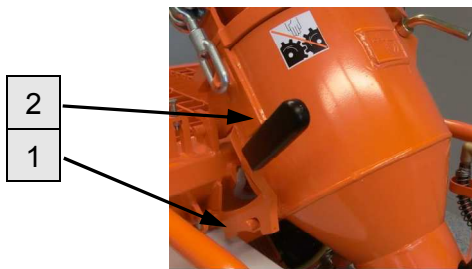

Fig. 99: Fold up mixing tube

1. Secure the machine against switching on by removing the connection cable.
2. Loosen locking lever (1).



**NOTE!**

Ensure that the locking lever engages at the mixing tube (2).

### 47.2 Clean rubber mixing section

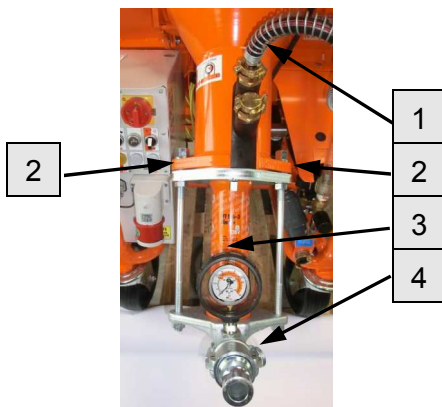

Fig. 100: Remove pump unit

1. Remove water inlet (1) from rubber mixing section.
2. Loosen nuts (2).
3. Remove pump assembly (3) with pressure flange (4) and mortar pressure gauge and clean.

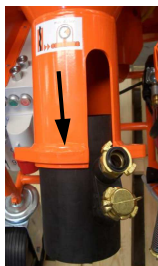

Fig. 101: Clean rubber mixing section

4. Pull the rubber mixing section out from the hopper and clean it
5. Replace and/or reinstall the rubber mixing section and pump assembly after cleaning. Ensure proper fit of the parts.

## 48 Switch off G 4 X

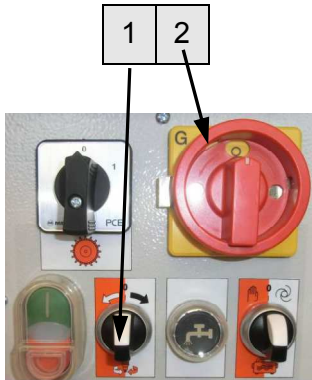

Fig. 102: Switching off

1. Switch off the machine at the selector switch of the pump motor (1) (position "0").
2. Turn main switch (2) to position "0".

## 49 Measures in case of risk of frost



**ATTENTION!**  
**Damage by frost!**

Water that expands inside the machine during frost can cause severe damage.

Therefore:

- The following steps are to be carried out if the machine stands still in case of risk of frost.



Fig. 103: Disconnect water supply

1. Close external water supply.
2. Disconnect the water hose (1) from the mixing tube.
3. Open draining cocks (2).

## Measures in case of risk of frost



4. Open and empty strainer.
5. Reassemble the strainer.

Fig. 104: Strainer

### 49.1 Blow dry water fitting

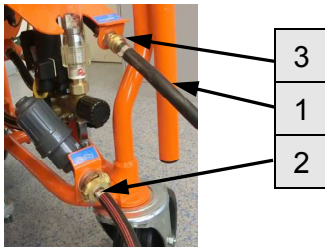

1. Connect water/air hose (1) with EWO and Geka coupling to the water inlet (2) and to the outlet of the air fitting (3).

Fig. 105: Dry water fitting

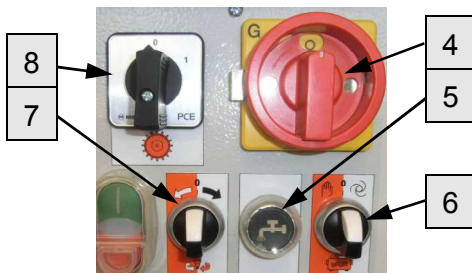

2. Turn main switch (4) to position "I".
3. Turn the selector switch of the booster pump (6) to position "0".
4. Turn the selector switch for the pump motor (7) to position "0".
5. Turn the star wheel (8) of the booster pump to position "0".

Fig. 106: Main switch

### 49.2 Switch on air compressor



1. Switch on the air compressor using the green toggle switch (1).
2. Press the water supply button (pos. 5 fig. 106).
2. The water is now blown out of the fitting using compressed air (for approx. 15 seconds).
3. Switch off the air compressor using the green toggle switch (1).
4. Turn the main switch to position "0".

Fig. 107: Air compressor

## 50 Maintenance

### 50.1 Safety

#### Personnel

- The maintenance works described here can be carried out by the operator, unless marked otherwise.
- Some maintenance work must only be carried out by specially trained technical personnel or exclusively by the manufacturer.
- Work on the electrical system must, in principle, be carried out only by electricians.

#### Basic information

**WARNING!****Risk of injury due to improperly carried out maintenance work!**

Improper maintenance can lead to severe injuries or considerable property damage.

Therefore:

- Ensure order and safety at the assembly site! Loose, stacked components or components lying about can cause accidents.
- If components were removed, ensure proper assembly, put back all fastening elements and observe torque indications for screws.

## 50.2 Remove connection cable

### Electrical system



Fig. 108: Remove connection cable



### **DANGER!** **Danger of death from electric current!**

There is danger to life if you come in contact with live parts. Activated electrical components can carry out uncontrolled movements and cause serious injuries.

Therefore:

- Switch off the energy supply before starting any work and secure against restarting.
- Disconnect the power supply by removing the connection cable

### Secure against restarting



### **DANGER!** **Danger to life from unauthorised restarting!**

When working with the tool, there is the risk that the energy supply is switched on without authorisation. This poses a danger to life for the persons in danger area.

Therefore:

- Switch off all power supplies before starting any work and secure against restarting.

## 50.3 Environmental protection

Observe the following notes on environmental protection when carrying out maintenance works:

- Remove the discharged, exhausted or surplus grease at all greasing points that are lubricated manually and dispose of in accordance with the local applicable regulations.
- Collect replaced oil in suitable containers and dispose of in accordance with the local applicable regulations.



## 50.4 Maintenance plan

The following paragraphs describe the maintenance works that are required for an ideal and trouble-free operation.

In the event that increased wear is detected during regular checks, the required maintenance intervals have to be shortened according to the actual signs of wear.

Should you have any queries regarding maintenance works and intervals contact the manufacturer, see page 2 for service addresses.



**NOTE!**

*Maintenance is limited to a few checks. Thorough cleaning after use is the most important maintenance.*

Interval	Maintenance work	To be carried out by
monthly	Clean/replace filter of compressor.	Service engineer
monthly	Clean/replace plastic sieve in strainer.	Operator
monthly	Clean/replace strainer screen in pressure reducer.	Service engineer

## 50.5 Maintenance work

### 50.5.1 Air filter compressor

- Execution by service technician.

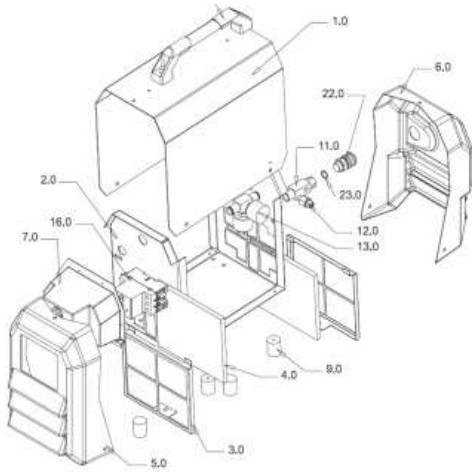

Fig. 109: Filter frame

1. Remove covers (5.0 and 6.0).
2. Take out filter frame (3.0).
3. Blow through the filter from the inside to the outside or tap it.
4. Replace the filter in case of heavy contamination.
5. Insert filter frame and screw back on the covers (5.0 and 6.0).

### 50.5.2 Plastic sieve

■ Implementation by operator.

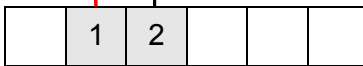

Fig. 110: Cleaning the sieve

1. Remove the closure cap (1) from the strainer.
2. Take out the plastic sieve (2) from the strainer (monthly).
3. Clean the sieve.
4. Replace the sieve in case of heavy contamination.
5. Put the sieve back.
6. Replace the closure cap.

### 50.5.3 Strainer screen in pressure reducer

■ Execution by service technician.

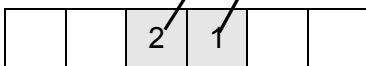
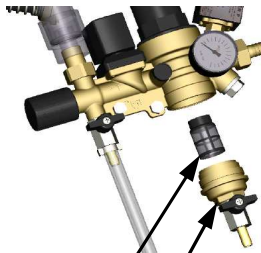

Fig. 111: Strainer screen

1. Remove the closure cap (1) from the pressure reducer.
2. Take out the strainer screen (2) and clean (monthly).
3. Replace the screen in case of heavy contamination.
4. Insert screen and screw on the closure cap.

Screen for pressure reducer: Article number 20156000

### 50.5.4 Setting value pressure switch water



Fig. 112: Pressure switch water

	Switching on the machine	Switching off the machine
Water	2.2 bar	1.9 bar



### 50.5.5 Setting value pressure switch air



Fig. 113: Pressure switch air

	Switching on the machine	Switching off the machine
Air	0.9 bar	1.2 bar

### 50.5.6 Setting value pressure switch air compressor

	Switch on air compressor	Switch off air compressor
Compressor	2.5 bar	3.1 bar

### 50.6 Adjust locking lever

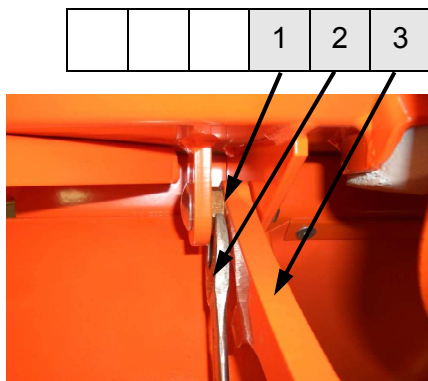

Fig. 114: Eccentric bushing



**NOTE!**

By turning the eccentric bushing (1) with the special wrench (2) in the tool bag, the locking lever (3) can be adjusted.

- Loosen locking lever and turn eccentric bushing.
- Close the locking lever and check if this action closes the mixing tube again tightly.

### 50.7 Measures after effected maintenance

1. After finishing the maintenance works and prior to switching on the machine, the following steps have to be carried out:
2. Check all previously loosened screw connections for secure fit.
3. Check if all previously removed safety systems and covers are properly reinstalled.
4. Ensure that all used tools, materials and other equipments were removed from the work area.

5. Clean the work area and remove any spilled materials such as liquids, processing material or similar.
6. Ensure that all safety systems of the installation work perfectly.

## 51 Disassembly

After the useful service life has been reached, the device has to be dismantled and disposed of in an environmental-friendly manner.

### 51.1 Safety

#### Personnel

- Disassembly must be carried out only by specially trained technical personnel.
- Work on the electrical system must be carried out by qualified electricians only.

#### Basic information



#### **WARNING!**

#### **Risk of injury in case of improper disassembly!**

Stored residual energies, sharp components, points or edges at and inside the device or at the required tools might cause injuries.

Therefore:

- Prior to starting the works ensure that there is sufficient space.
- Carefully handle components with sharp edges.
- Ensure order and cleanliness at the working place! Loose components and tools on top of another or lying about, pose potential accident risks.
- Dismantle components correctly. Pay attention to partly high dead weight of the components. If required use lifting equipment.
- Secure components that they do not fall down or fall over.
- In case of doubt, consult the dealer.

## Electrical system



### **DANGER!** **Danger of death from electric current!**

There is danger to life if you come in contact with live parts. Activated electrical components can carry out uncontrolled movements and cause serious injuries.

Therefore:

- Prior to beginning the disassembly, switch off the power supply and finally disconnect it.

## 51.2 Disassembly

Clean the device for phasing out and disassemble under observance of applicable health and safety rules as well as environmental regulations.

Prior to starting the disassembly:

- Switch off device and secure against restarting.
- Physically separate the complete energy supply to the device, discharge stored residual power.
- Remove operating supplies as well as remaining processing materials and dispose of in an environment-friendly way.

## 52 Disposal

If no agreement for the recovery or the disposal was made, recycle the disassembled components:

- Scrap metals.
- Recycle plastic elements.
- Dispose of remaining components, sorted according to the type of material.



### **ATTENTION!** **Environmental damage in case of incorrect disposal!**

Waste from electronic and electrical equipment, electronic components, lubricants and other auxiliary materials are subject to hazardous waste treatment and must be disposed of by specialised companies only!

The local authority or special waste management operators can supply information on environmentally-friendly disposal.

## 53 Index

Accessories.....	16	Connections .....	15
Adapter cable.....	17	Control cabinet item number 00 25 46 51.....	13
Adjust locking lever .....	65	Decouple mortar hose.....	55
Air compressor DELTA2 230V with pressure switch-off .....	14	Description of assemblies .....	13
Air filter compressor.....	63	Description PFT Booster pump (Accessory).....	21
Anti-dust unit G 4 .....	35	Dimension sheet .....	11
Apply mortar.....	40	Disassembly.....	67
Assembly .....	12	Disassembly.....	66
Blockage does not dislodge.....	50	Disposal .....	67
Blow dry water fitting.....	60	Division.....	8
Causes for this can be: .....	49	Dry-running air compressor .....	20
Change the direction of rotation of the mixing pump motor in case of blockages in the hose (230V).....	50	Earlier damage to the mortar hose .....	49
Change the direction of rotation of the mixing pump motor in case of blockages in the hose (400V).....	49	EG Konformitätserklärung.....	6
Changing the pump / Cleaning the pump .....	58	Emergency-stop switch.....	42
Check consistency of mortar .....	37	Empty the mixing tube .....	54
Check the individual connectors.....	31	Environmental protection .....	62
Clean.....	58	Estrich .....	40
Clean mortar hose .....	55	Examination .....	7
Cleaning the G 4 X .....	55	Examination by machine operator .....	7
Cleaning the hopper .....	58	Fault displays .....	45
Cleaning the machine after work .....	54	Faults .....	45
Cleaning the mixing tube .....	56	Feeding dry material to the machine.....	35
Close motor tilt flange .....	57	Fields of application .....	24
Compressed air supply .....	39	Flowability / Flow characteristics.....	24
Connect air hose.....	39	Fold up mixing tube.....	58
Connect mortar hose .....	38	Functional.....	23
Connecting the power supply 230V .....	52	Functional principle G 4 X FU 230/400V .....	24
Connecting the power supply 400V .....	30	General information .....	8, 9
Connecting the spraying gun .....	39	Hazardous dusts .....	34
Connecting the water supply .....	31	Hopper .....	13
Connection of power supply (230V) .....	52	In case of longer interruption of work/break.....	41
Connection of water from water tank.....	32	Index .....	68
		Information regarding the operating manual.....	8
		Initial start-up booster pump .....	22
		Insert agitator .....	57
		Insert the mixing tube cleaner.....	56



Intended purpose air compressor.....	19	Pressure switch-off air compressor .....	20
Intended purpose control panel.....	18	Protective gear	
Intended purpose flow meter .....	18	Installation .....	45
Intended purpose solenoid valve.....	18	Putting the machine into operation .....	37
Intended use .....	21	Putting the machine into operation (230V) .....	53
Intended use air compressor .....	19	Putting the machine into operation (400V) .....	33
Intended use control panel .....	18	Quality Control sticker.....	11
Interruption of work .....	41	Reaction in the event of faults .....	44
Keep the manual for future reference.....	8	Relieve mortar pressure .....	43
Main switch to position 0 .....	43	Remote control .....	42
Maintenance .....	61	Removal of blockages in the hose.....	49
Maintenance plan .....	63	Remove connection cable .....	62
Maintenance work .....	63	Remove the water hose.....	56
Material .....	24	Safety .....	45, 61
Measures after effected maintenance .....	65	Safety .....	29
Measures in case of power cut.....	43	Safety .....	66
Measures in case of risk of frost.....	59	Safety instructions for transport.....	25
Mixing tube with motor and pump .....	14	Safety rules .....	25
Monitoring the machine .....	36	Safety system .....	29
Mortar hoses.....	38	Safety systems air compressor.....	20
Mortar pressure gauge .....	25, 34	Scope of application Booster pump.....	21
Name plate .....	11	Secure against restarting.....	54
Open the air tap at the spraying gun .....	40	Selector switch pressure booster pump .....	16
Operating conditions.....	9	Selector switch pump motor .....	15
Operating modes .....	15	Selector switch star wheel .....	15
Operation .....	29	Set water quantity .....	33
Overview.....	12	Setting value pressure switch air .....	65
Packaging .....	28	Setting value pressure switch air compressor....	65
Periodic inspection .....	7	Setting value pressure switch water .....	64
Personnel		Signs for hose blockages.....	48
Disassembly.....	66	Soaking of the mixing section .....	34
Installation .....	45	Sound power level .....	10
Initial startup .....	45	Spare parts lists .....	8
Plastic sieve.....	64	Start the machine in a .....	37, 53
Power connection .....	9	Start-up Booster pump.....	22
Power values .....	10	Stillsetzen im Notfall .....	42
Prepare mortar hoses.....	38	Stopping in case of emergency Emergency-stop switch .....	42
Preparing the machine .....	30	Strainer screen in pressure reducer .....	64



Switch off air compressor .....	41	Transport in individual parts .....	28
Switch off G 4 X .....	59	Transport inspection .....	26
Switch on air compressor .....	39, 60	Transport with van .....	27
Switch the machine back on after the blockage has been removed (230V).....	51	Transport, packing and storage .....	25
Switch the machine back on after the blockage has been removed (400V).....	51	Vibrations .....	10
Switching on (230V).....	53	Voltage 230/400V changing.....	16
Switching on the G 4 X (400V)) .....	33	Voltage 230V.....	52
Table of faults .....	46	Vorbereitung AV3.....	22
Technical data.....	9	Water fitting .....	14
Transport.....	27	Work on troubleshooting .....	44
		Working with the remote control .....	42





THE FLOW OF PRODUCTIVITY



Knauf PFT GmbH & Co. KG  
P.O. Box no. 60 97343 Iphofen  
Einersheimer Straße 53 97346 Iphofen  
Germany

Phone +49 9323 31-760  
Fax +49 9323 31-770  
Technical hotline +49 9323 31-1818  
info@pft-iphofen.de  
www.pft.eu